



# JHALANI EXTRUSION

(A UNIT OF P.R.C.M. METAL)

C-36, Riico Industrial Area, Neemrana, District : Alwar, (Raj.) 301705

Contact : 9716031516, 09953239231 E-Mail : jhalaniextrusion@yahoo.com

## DOOR SECTION

## ARCHITECTURAL

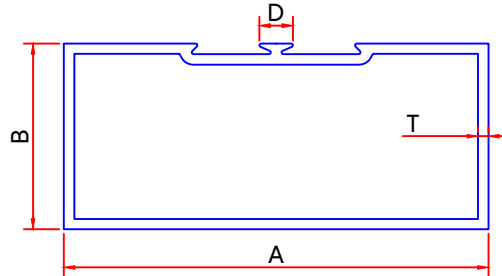

### SINGLE PARTITION

SR. NO.	SEC. NO.	A	B	T	D	WEIGHT/15'
1	2500	50.80	25.40	0.91	7.50	1.85-2.30
2	2501	50.80	25.40	1.09	7.50	2.20-2.50
3	2502	50.80	25.40	1.30	7.50	2.60-3.00
4	2503	63.50	38.10	0.92	7.50	2.50-2.70
5	2504	63.50	38.10	1.01	7.50	2.70-3.10
6	2505	63.50	38.1000	1.31	8.00	3.40-3.60
7	2506	63.50	38.10	1.50	8.00	3.80-4.10
8	2507	63.50	38.10	1.65	8.00	4.20-4.60
9	2508	63.50	38.10	1.90	8.00	4.70-5.10
10	2509	63.50	38.10	2.25	8.00	5.60-6.00
11	2510	63.50	38.10	2.85	8.00	6.80-7.10
12	2511	63.50	38.10	3.00	8.00	7.80-8.20
13	2512	82.50	38.00	1.50	8.00	4.80-5.30
14	2513	82.50	38.00	3.00	8.00	8.70-9.20
15	2525	92.00	45.00	1.44	8.00	4.80-5.30
16	2524	89.00	32.00	2.75	23.00	8.80-9.50
17	2531	101.60	44.45	1.27	8.00	4.80-5.10
18	2532	101.60	44.45	1.45	8.00	5.50-6.00
19	2533	101.60	44.45	1.55	8.00	6.00-6.50
20	2534	101.60	44.45	1.85	8.00	6.80-7.10
21	2535	101.60	44.45	2.25	8.00	8.50-9.10
22	2536	101.60	44.45	2.95	8.00	10.50-11.00
23	2550	127.00	44.45	2.00	8.00	8.80-9.50



# JHALANI EXTRUSION

(A UNIT OF P.R.C.M. METAL)

C-36, Riico Industrial Area, Neemrana, District : Alwar, (Raj.) 301705  
Contact : 9716031516, 09953239231 E-Mail : jhalaniextrusion@yahoo.com

## DOOR SECTION

## ARCHITECTURAL

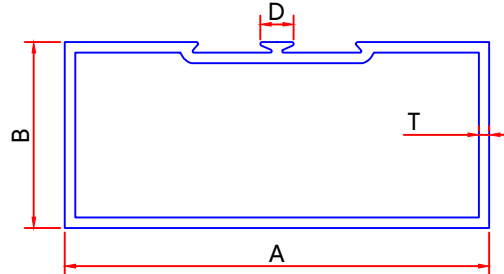

### SINGLE PARTITION

SR. NO.	SEC. NO.	A	B	T	D	WEIGHT/15'
24	2551	127.00	44.45	2.50	8.00	10.50-11.00
25	2552	127.00	44.45	3.00	8.00	12.40-13.00
26	2555	89.00	32.00	2.00	7.80	6.30-6.60
27	2556	94.00	38.00	1.20	7.80	4.80-5.00



## DOOR SECTION

## ARCHITECTURAL

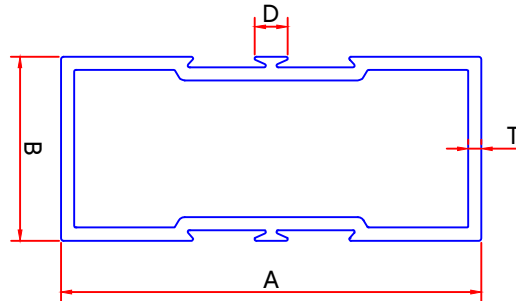

### DOUBLE PARTITION

SR. NO.	SEC. NO.	A	B	T	D	WEIGHT/15'
1	2600	50.80	25.40	0.79	7.50	1.85-2.30
2	2601	50.80	25.40	1.19	7.50	2.20-2.50
3	2602	50.80	25.40	1.34	7.50	2.60-3.00
4	2603	63.50	38.10	0.83	7.50	2.50-2.70
5	2604	63.50	38.10	0.92	7.50	2.70-3.10
6	2605	63.50	38.10	1.21	8.00	3.40-3.60
7	2606	63.50	38.10	1.35	8.00	3.80-4.10
8	2607	63.50	38.10	1.53	8.00	4.20-4.60
9	2608	63.50	38.10	1.85	8.00	4.70-5.10
10	2609	63.50	38.10	2.15	8.00	5.60-6.00
11	2610	63.50	38.10	2.81	8.00	6.80-7.10
12	2611	63.50	38.10	2.95	8.00	7.80-8.20
13	2612	82.50	38.00	1.52	8.00	4.80-5.30
14	2613	82.50	38.00	2.75	8.00	8.70-9.20
15	2624	92.00	45.00	1.40	8.00	4.80-5.30
16	2625	89.00	32.00	2.67	23.00	8.80-9.50
17	2631	101.60	44.45	1.25	8.00	4.80-5.10
18	2632	101.60	44.45	1.42	8.00	5.50-6.00
19	2633	101.60	44.45	1.51	8.00	6.00-6.50
20	2634	101.60	44.45	1.80	8.00	6.80-7.10
21	2635	101.60	44.45	2.20	8.00	8.50-9.10
22	2636	101.60	44.45	2.90	8.00	10.50-11.00
23	2650	127.00	44.45	1.95	8.00	8.80-9.50
24	2651	127.00	44.45	2.45	8.00	10.50-11.00



## DOOR SECTION

## ARCHITECTURAL

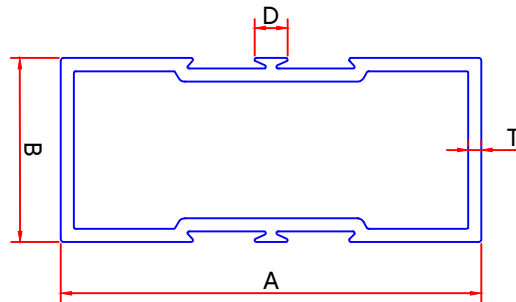

### DOUBLE PARTITION

SR. NO.	SEC. NO.	A	B	T	D	WEIGHT/15'
25	2652	127.00	44.45	2.95	8.00	12.40-13.00
26	2655	89.00	32.00	2.00	7.80	6.30-6.60
27	6008	150.00	44.45	3.00	7.20	14.50-14.80
28	6041	127.00	44.00	2.00	7.20	8.80-9.20
29	6043	127.00	44.00	3.00	7.20	12.80-13.20



# JHALANI EXTRUSION

(A UNIT OF P.R.C.M. METAL)

C-36, Riico Industrial Area, Neemrana, District : Alwar, (Raj.) 301705

Contact : 9716031516, 09953239231 E-Mail : jhalaniextrusion@yahoo.com

## DOOR SECTION

## ARCHITECTURAL

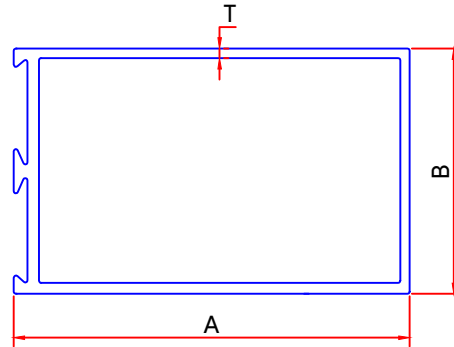

**DOOR MIDDLE SINGLE**

SR. NO.	SEC. NO.	A	B	T	WEIGHT/15'
1	2750	47.00	44.00	1.25	2.30-2.60
2	2751	47.00	44.00	1.38	2.70-3.00
3	2752	47.00	44.00	1.73	3.70-4.00
4	2753	47.00	44.00	2.23	4.70-5.00
5	2754	47.00	44.00	3.10	6.80-7.30
6	2801	83.00	44.00	1.59	4.70-5.00
7	2802	83.00	44.00	1.75	5.00-5.50
8	2803	83.00	44.00	1.98	5.80-6.10
9	2804	83.00	44.00	2.20	6.50-7.10
10	2805	83.00	44.00	3.00	9.50-9.80



## DOOR SECTION

## ARCHITECTURAL

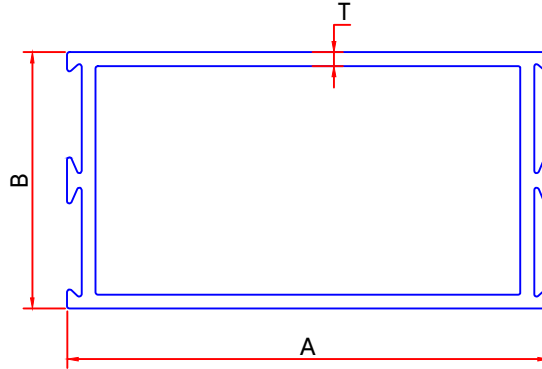

### DOOR MIDDLE DOUBLE

SR. NO.	SEC. NO.	A	B	T	WEIGHT/15'
1	2702	47.00	44.00	1.25	2.40-2.70
2	2703	47.00	44.00	1.30	2.70-3.00
3	2704	47.00	44.00	1.35	3.00-3.30
4	2705	47.00	44.00	1.45	3.30-3.60
5	2706	47.00	44.00	1.80	3.70-4.00
6	2707	47.00	44.00	2.20	4.70-5.10
7	2708	47.00	44.00	3.10	6.80-7.30
8	2806	83.00	44.00	1.40	4.70-5.00
9	2807	83.00	44.00	1.55	5.00-5.50
10	2808	83.00	44.00	1.98	5.80-6.10
11	2809	83.00	44.00	2.20	6.80-7.10
12	2810	83.00	44.00	3.03	9.50-9.80



# JHALANI EXTRUSION

(A UNIT OF P.R.C.M. METAL)

C-36, Riico Industrial Area, Neemrana, District : Alwar, (Raj.) 301705

Contact : 9716031516, 09953239231 E-Mail : jhalaniextrusion@yahoo.com

## DOOR SECTION

## ARCHITECTURAL

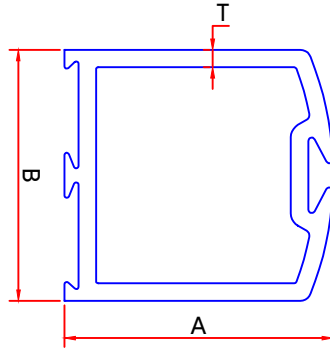

**DOOR VERTICAL**

SR. NO.	SEC. NO.	A	B	T	WEIGHT/15'
1	2760	47.00	44.00	1.00	2.50-2.70
2	2761	47.00	44.00	1.10	2.70-3.00
3	2762	47.00	44.00	1.30	3.00-3.30
4	2763	47.00	44.00	1.45	3.30-3.60
5	2764	47.00	44.00	1.60	3.70-4.00
6	2765	47.00	44.00	2.00	4.70-5.00
7	2766	47.00	44.00	3.00	6.70-7.00
8	2816	83.00	44.00	1.45	4.70-5.00
9	2817	83.00	44.00	1.65	5.50-6.50
10	2818	83.00	44.00	1.80	6.00-6.50
11	2819	83.00	44.00	2.10	6.80-7.10
12	2820	83.00	44.00	2.85	9.50-10.30



## DOOR SECTION

## ARCHITECTURAL

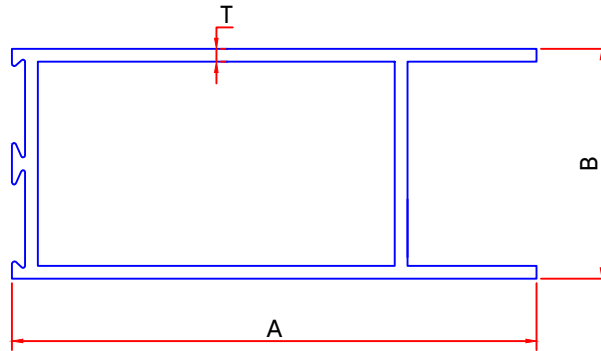

## DOOR BOTTOM

SR. NO.	SEC. NO.	A	B	T	WEIGHT/15'
1	2770	47.00	44.00	1.10	2.50-2.70
2	2771	47.00	44.00	1.15	2.70-3.00
3	2772	47.00	44.00	1.30	3.00-3.30
4	2773	47.00	44.00	1.40	3.30-3.60
5	2774	47.00	44.00	1.65	3.70-4.00
6	2775	47.00	44.00	2.00	4.60-5.00
7	2776	47.00	44.00	2.95	6.70-7.10
8	2811	83.00	44.00	1.50	4.70-5.00
9	2812	83.00	44.00	2.15	6.70-7.00
10	2813	83.00	44.00	3.00	9.50-10.00
11	2821	114.00	44.00	1.15	4.70-5.00
12	2822	114.00	44.00	1.30	5.30-5.60
13	2823	114.00	44.00	1.54	5.60-6.00
14	2824	114.00	44.00	1.70	6.70-7.00
15	2825	114.00	44.00	2.27	8.50-9.00
16	2826	114.00	44.00	2.55	10.00-10.50
17	6023	150.00	44.00	3.00	14.00-15.00



## DOOR SECTION

## ARCHITECTURAL

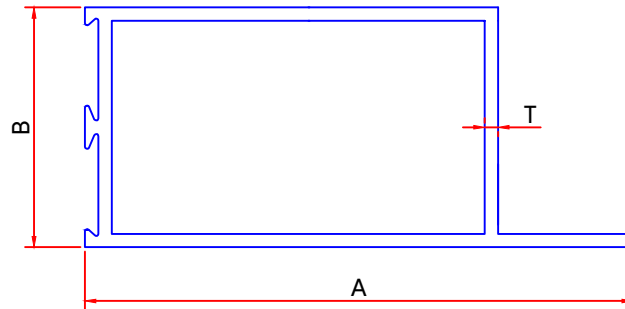

**DOOR BOTTOM SINGLE LEG**

SR. NO.	SEC. NO.	A	B	T	WEIGHT/15'
1	2731	47.00	44.00	1.10	2.90-3.30
2	2732	47.00	44.00	1.40	3.50-3.80
3	2733	47.00	44.00	1.65	3.80-4.00
4	2734	47.00	44.00	1.45	4.50-5.00
5	2735	47.00	44.00	2.90	6.50-7.00
6	2740	83.00	44.00	1.45	4.70-5.00
7	2741	83.00	44.00	2.10	6.50-7.00
8	2742	83.00	44.00	3.00	9.20-9.50
9	2742	75.00	44.00	3.00	8.00-8.40



# JHALANI EXTRUSION

(A UNIT OF P.R.C.M. METAL)

C-36, Riico Industrial Area, Neemrana, District : Alwar, (Raj.) 301705

Contact : 9716031516, 09953239231 E-Mail : jhalaniextrusion@yahoo.com

## DOOR SECTION

## ARCHITECTURAL

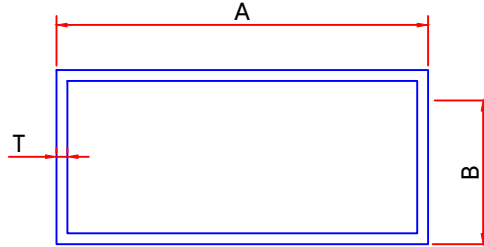

### RECTENGULAR TUBE

SR. NO.	SEC. NO.	A	B	T	WEIGHT/15'
1	8398	25.00	12.00		1.00
2	1510	30.00	20.00	1.20	1.100-1.300
3	1511	30.00	20.00	1.60	1.480-1.650
4	7021	33.50	23.50	0.60	0.600
5	1504	35.00	15.00		1.850
6	7021	36.50	23.50	1.00	1.100
7	7365	37.00	25.60	0.95	1.040
8	1527	38.00	25.00	1.00	1.200-1.400
9	1528	38.00	25.00	1.25	1.500-1.700
10	1529	38.00	25.00	1.80	2.100-2.300
11	1530	38.00	25.00	2.50	2.860-3.100
12	1531	38.00	25.00	3.00	3.400-3.700
13	1520	40.00	20.00	1.50	1.700-1.900
14	1520	40.00	20.00	3.00	3.200-3.500
15	7366	48.10	24.30	0.95	1.230
16	1515	50.00	20.00	1.20	1.600-1.900
17	1516	50.00	25.00	1.50	2.000-2.500
18	1517	50.00	38.00		1.950
19	1536	50.00	25.00	0.90	1.300-1.500
20	1537	50.00	25.00	1.20	1.700-2.100
21	1538	50.00	25.00	1.8000	2.500-2.800
22	1539	50.00	25.00	2.35	3.200-3.500
23	1540	50.00	25.00	3.00	4.000-4.500
24	8536	50.00	12.00		1.100
25	1581	55.58	15.88	2.80	4.000-4.300
26	7356	62.40	28.40	1.20	2.156
27	1550	63.00	38.00	0.80	1.500-1.700
28	1551	63.00	38.00	0.95	1.700-2.000



# JHALANI EXTRUSION

(A UNIT OF P.R.C.M. METAL)

C-36, Riico Industrial Area, Neemrana, District : Alwar, (Raj.) 301705

Contact : 9716031516, 09953239231 E-Mail : jhalaniextrusion@yahoo.com

## DOOR SECTION

## ARCHITECTURAL

SR. NO.	SEC. NO.	A	B	T	WEIGHT/15'
29	1552	63.00	38.00	2.50	4.750-5.000
30	1572	63.00	38.00	1.80	3.500-3.800
31	1573	63.00	38.00	2.50	4.750-5.000
32	1583	63.00	20.00		4.500
33	1584	63.00	25.00		1.600
34	1565	75.00	25.00	2.00	3.800-4.100
35	1585	75.00	12.00		2.300
36	1586	75.00	38.00		4.400
37	8516	75.00	50.00		4.750
38	1575	80.00	20.00	2.00	3.800-4.000
39	1576	80.00	50.00	2.00	5.000-5.300
40	1577	80.00	50.00	3.00	7.000-7.400
41	8036	83.00	38.00		4.700
42	1568	92.00	49.00	1.50	4.100-4.500
43	1563	95.00	49.00	2.00	3.950-4.300
44	1564	96.00	19.00		3.350
45	1518	100.00	50.00	1.50	4.350-4.700
46	1519	100.00	50.00	3.00	8.500-8.800
47	1560	100.00	25.00	1.50	3.600-3.900
48	1561	100.00	25.00	2.50	5.900-6.300
49	1562	100.00	25.00	3.00	7.000-7.300
50	1587	100.00	62.00	0.00	12.500
51	1588	100.00	15.00	0.00	4.500
52	1589	100.00	35.00	0.00	3.900
53	1575	101.00	45.00	1.60	4.500-4.800
54	1576	101.00	45.00	2.00	5.600-5.900
55	1577	101.00	45.00	2.50	7.000-7.300
56	1578	101.00	45.00	3.30	9.000-9.500
57	1512	125.00	45.00	1.80	6.000-6.300
58	1582	125.00	20.00	4.00	10.800-11.500
59	6207	125.00	75.00	2.00	7.747
60	6235	125.00	50.00	2.00	6.700
61	6241	125.00	62.00	2.00	7.000
62	1513	127.00	45.00	2.30	7.000-7.300



# JHALANI EXTRUSION

(A UNIT OF P.R.C.M. METAL)

C-36, Riico Industrial Area, Neemrana, District : Alwar, (Raj.) 301705

Contact : 9716031516, 09953239231 E-Mail : jhalaniextrusion@yahoo.com

## DOOR SECTION

## ARCHITECTURAL

SR. NO.	SEC. NO.	A	B	T	WEIGHT/15'
63	1514	127.00	45.00	3.30	10.450-10.800
64	6006	127.00	44.00	3.00	10.100
65	6044	150.00	50.00	2.00	7.500
66	15025	150.00	25.00	2.00	6.600
67	6288	150.00	50.00	2.00	7.747 / 12'



# JHALANI EXTRUSION

(A UNIT OF P.R.C.M. METAL)

C-36, Riico Industrial Area, Neemrana, District : Alwar, (Raj.) 301705

Contact : 9716031516, 09953239231 E-Mail : jhalaniextrusion@yahoo.com

## DOOR SECTION

## ARCHITECTURAL

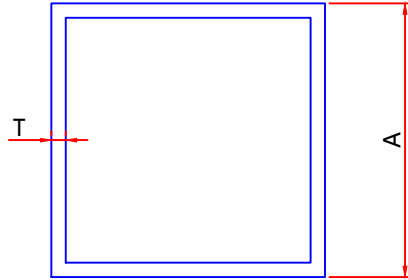

**SQUARE TUBE**

SR. NO.	SEC. NO.	A	T	WEIGHT/12'
1	7627	10.00	1.00	0.354
2	1575	13.00	3.50	1.18-1.35
3	1576	15.00	1.00	0.55-0.65
4	1577	15.00	2.00	0.80-1.00
5	1578	19.00	1.15	0.80-1.00
6	1579	19.00	1.50	1.05-1.20
7	1580	25.00	1.50	1.40-1.60
8	1581	25.00	2.00	1.80-2.00
9	1582	40.00	2.00	3.00-3.20
10	1583	40.00	2.50	3.70-3.90
11	1584	50.00	1.60	3.00-3.30
12	1585	50.00	2.00	3.80-4.00
13	1586	50.00	3.00	5.57-5.75
14	1587	50.00	4.00	7.25-7.50
15	1588	75.00	3.00	8.60-9.00
16	1589	38.00	1.20	1.40-1.60



## DOOR SECTION

## ARCHITECTURAL

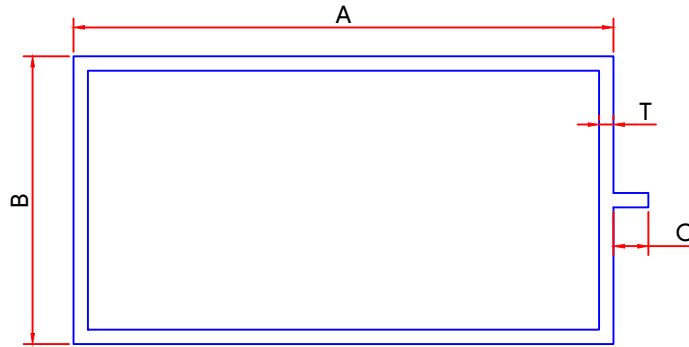

### STRUCTURE GLAZING

SR. NO.	SEC. NO.	A	B	C	T	WEIGHT/15'
1	4005	50.00	50.00	6.00	1.30	3.40-3.70
2	4006	50.00	50.00	6.00	2.00	4.80-5.20
3	4007	50.00	50.00	8.00	1.30	3.40-3.70
4	4008	50.00	50.00	8.00	2.00	4.80-5.20
5	4010	65.00	58.00	6.00	1.50	4.50-4.80
6	4011	65.00	58.00	8.00	2.00	4.50-4.80
7	4015	83.00	50.00	5.00	1.50	4.80-5.10
8	4016	83.00	50.00	7.00	1.50	4.80-5.10
9	4017	83.00	50.00	10.00	1.50	5.00-5.50
10	4018	83.00	50.00	28.00	2.00	6.80-7.30
11	4021	100.00	55.00	5.00	1.80	6.80-7.30
12	4022	100.00	55.00	12.00	1.80	6.90-7.50
13	4023	100.00	55.00	12.00	2.40	9.50-10.00
14	4024	100.00	55.00	12.00	3.45	13.00-13.50
15	1320	44.50	101.60	12.70	2.50	7.10-7.50
16	1321	44.50	101.60	12.70	3.00	9.10-9.50



## DOOR SECTION

## ARCHITECTURAL

### SINGLE PATAM SECTION

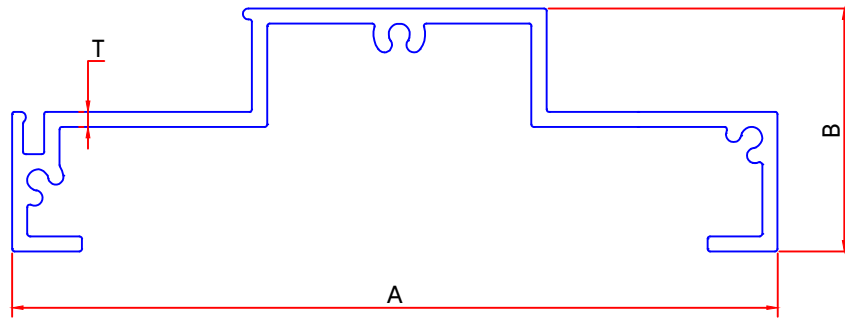

SEC. NO.	A	B	T	WEIGHT/12'
5052	123.75	38.80	1.65	4.00-4.30
5050	123.75	38.80	3.00	7.30-7.80

SEC. NO. : 5061

### SINGLE PATTAM SECTION

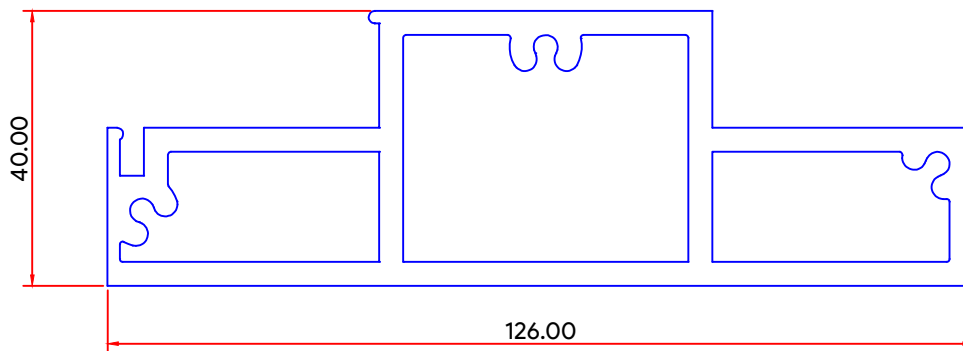

WEIGHT. : 12.80-13.50 / 12'

### ROUGH GROUND

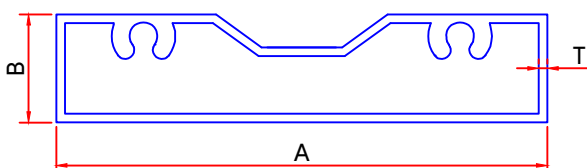

SEC. NO.	A	B	T	WEIGHT/12'
JE-289	50.00	12.00	1.40	1.90-2.20
JE-189	30.00	15.00	1.00	1.10-1.30



## DOOR SECTION

## ARCHITECTURAL

### DOUBLE PATAM SECTION

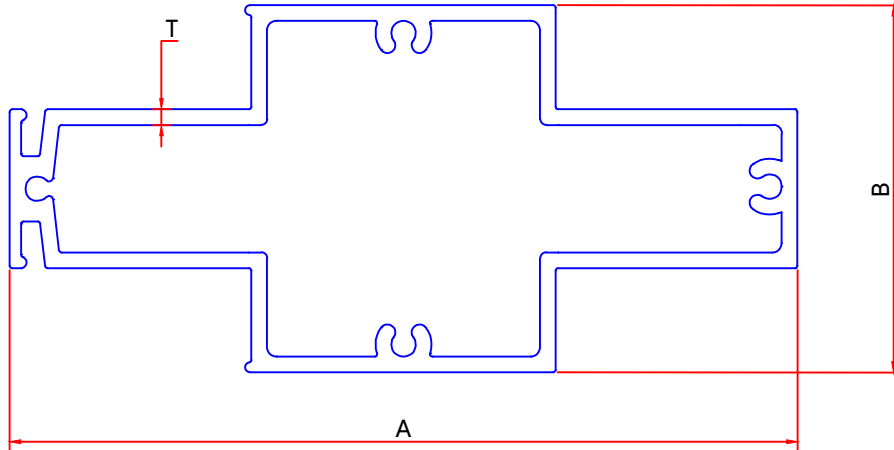

SEC. NO.	A	B	T	WEIGHT/12'
5051	123.75	57.00	1.60	6.30-6.80
5049	123.75	57.00	3.00	11.80-12.30

SEC. NO. : 5065

### DOUBLE PATTAM SECTION

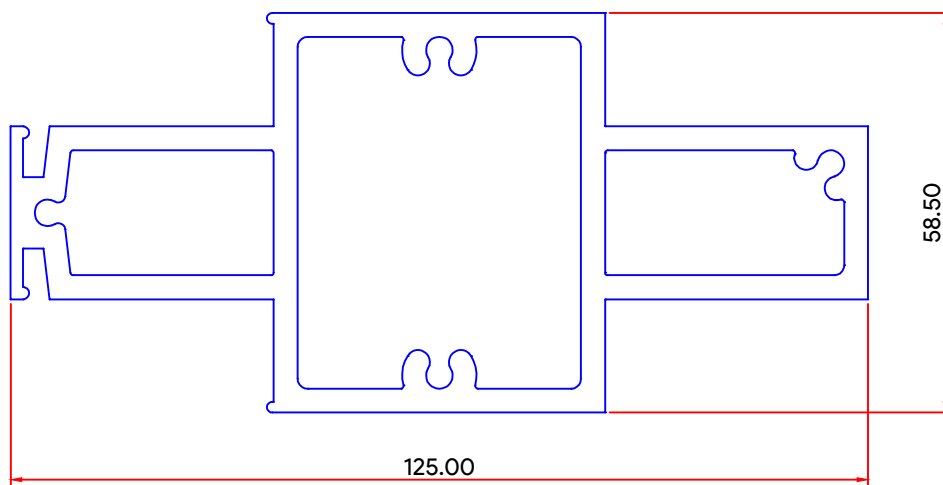

WEIGHT. : 14.40-14.80 / 12'



# JHALANI EXTRUSION

(A UNIT OF P.R.C.M. METAL)

C-36, Riico Industrial Area, Neemrana, District : Alwar, (Raj.) 301705  
Contact : 9716031516, 09953239231 E-Mail : jhalaniextrusion@yahoo.com

## DOOR SECTION

## ARCHITECTURAL

SEC. NO. : 8579

MATCHING WITH 8580

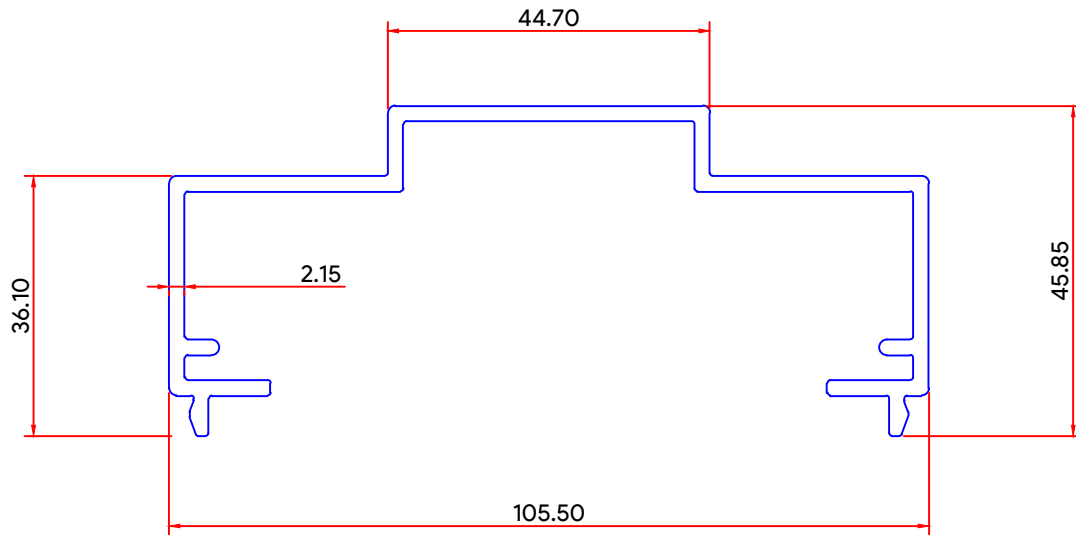

WEIGHT. : 6.000 / 15'

SEC. NO. : 8580

MATCHING WITH 8579

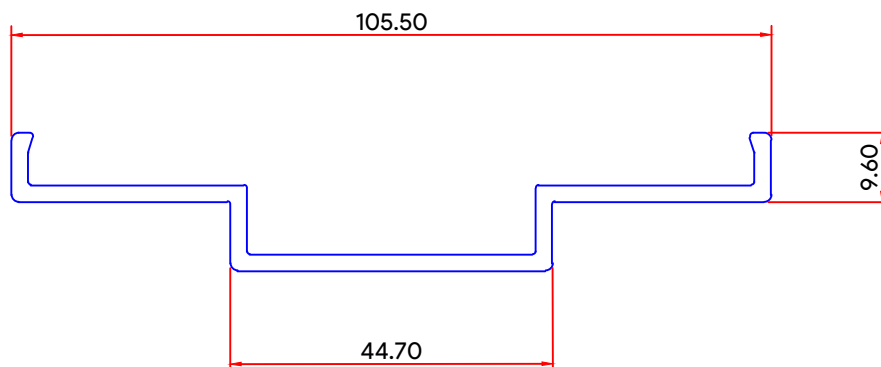

WEIGHT. : 3.970 / 15'



## DOOR SECTION

## ARCHITECTURAL

### SINGLE PARTITION LEG

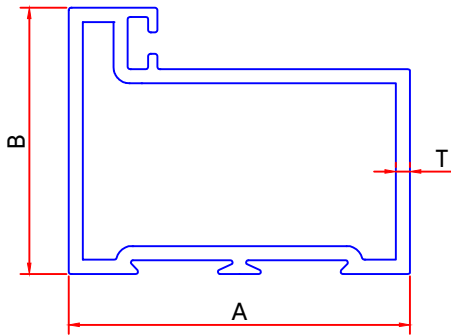

SEC. NO.	A	B	T	WEIGHT/15'
2401	63.50	49.50	1.30	4.50-4.80
2402	63.50	49.50	1.60	5.00-5.50
2403	63.50	49.50	2.00	6.20-6.50
2404	63.50	49.50	2.50	7.80-8.30

### FLUSH DOOR

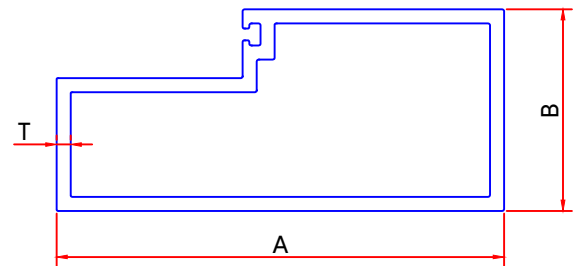

SEC. NO.	A	B	T	WEIGHT/15'
14050	63.50	38.00	1.50	3.60-4.00
14060	63.50	38.00	1.80	4.50-4.90
14070	63.50	38.00	2.50	5.90-6.30
14080	45.00	24.00	1.10	1.70-2.00
14090	45.00	24.00	1.50	2.50-2.80
14100	101.00	45.50	3.00	10.80-11.80
8303	101.00	45.20	1.64	5.875

SEC. NO. : 5001

GLASS SECTION

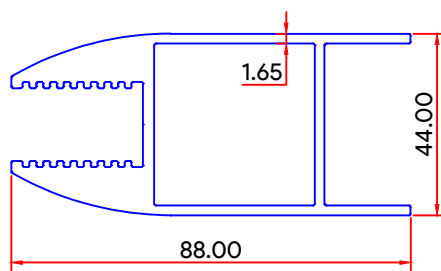

WEIGHT. : 10.50-11.00 KG / 15'

SEC. NO. : 1010

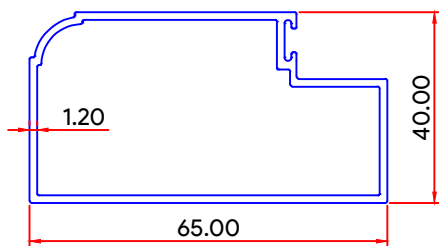

WEIGHT. : 2.40-2.60 KG / 15'

L-PIPE

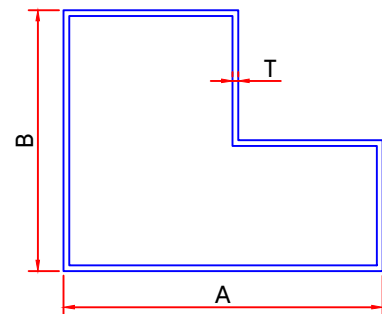

SEC. NO.	A	B	T	WEIGHT/12'
11007	55.55	45.45	0.68	1.30-1.60
11008	38.00	24.00	0.70	0.800-1.00
11009	38.00	24.00	0.95	1.10-1.30



## DOOR SECTION

## ARCHITECTURAL

SEC. NO. : 5001

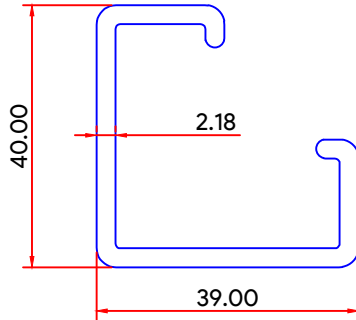

WEIGHT. : 2.50-3.00 / 12'

SEC. NO. : JD-100

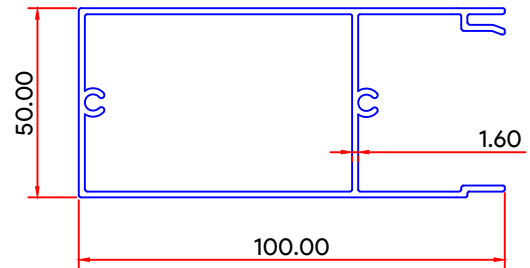

WEIGHT. : 5.70-6.00 / 12'

SEC. NO. : JD-110

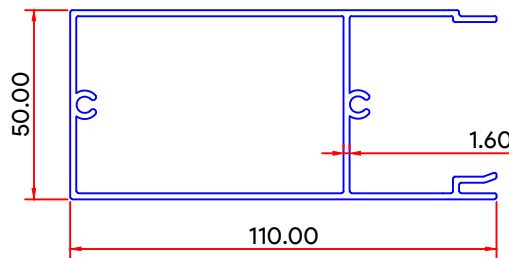

WEIGHT. : 5.70-6.00 / 12'

SEC. NO. : 6266

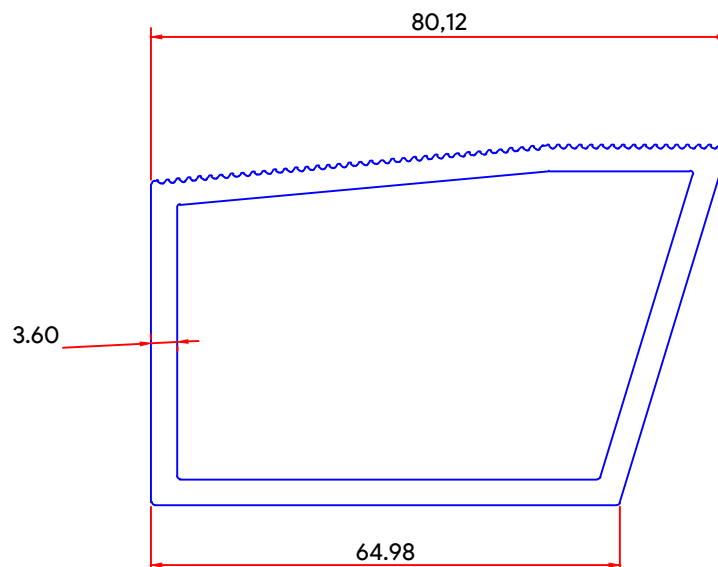

WEIGHT. : 7.915 KG / 12'



# JHALANI EXTRUSION

(A UNIT OF P.R.C.M. METAL)

C-36, Riico Industrial Area, Neemrana, District : Alwar, (Raj.) 301705  
Contact : 9716031516, 09953239231 E-Mail : jhalaniextrusion@yahoo.com

## DOOR SECTION

## ARCHITECTURAL

SEC. NO. : 6232

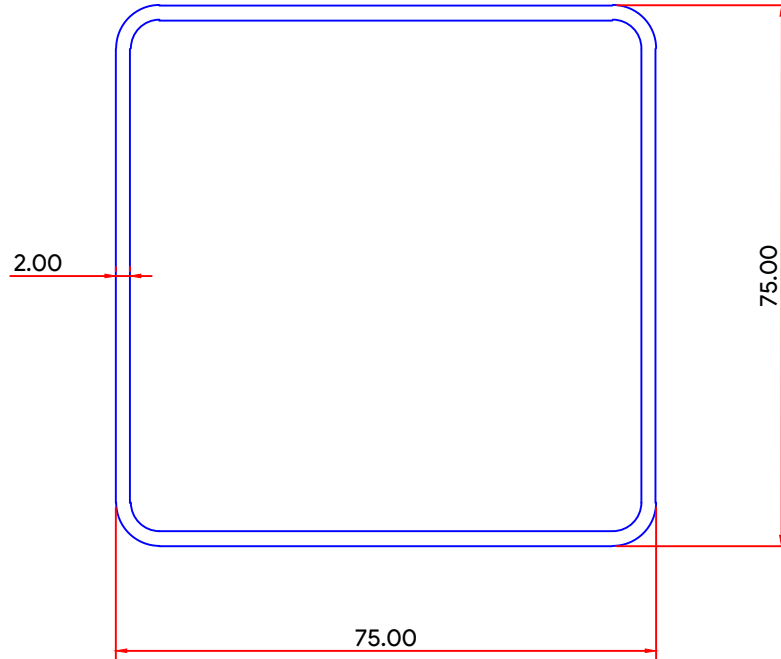

WEIGHT. : 5.600 / 12'

SEC. NO. : 6287

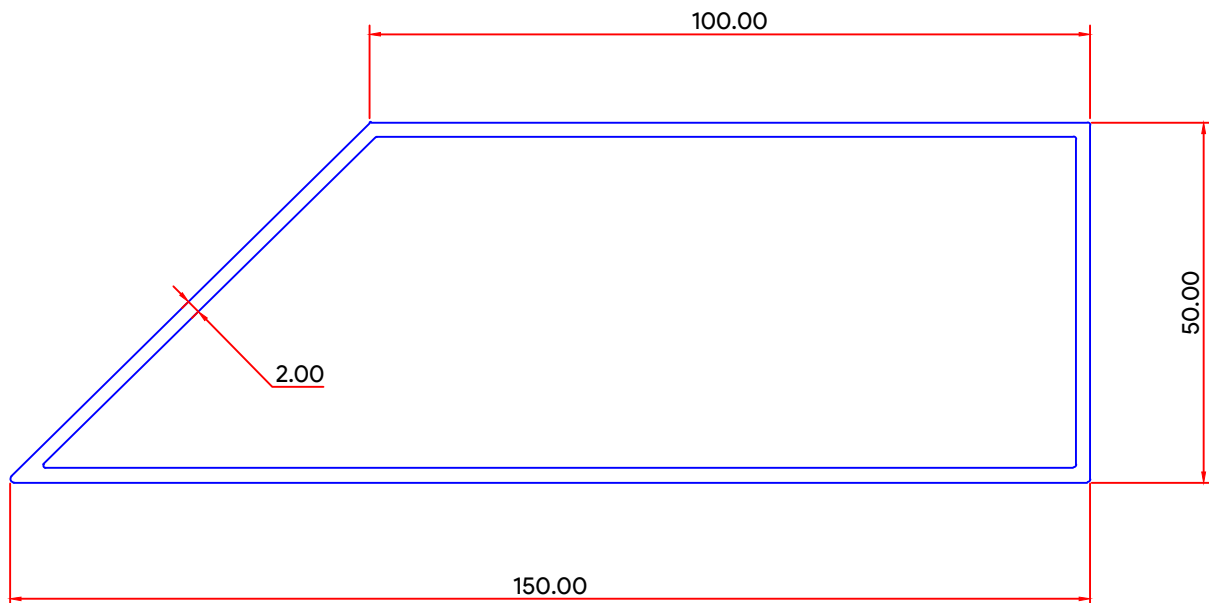

WEIGHT. : 7.147 / 12'



# JHALANI EXTRUSION

(A UNIT OF P.R.C.M. METAL)

C-36, Riico Industrial Area, Neemrana, District : Alwar, (Raj.) 301705  
Contact : 9716031516, 09953239231 E-Mail : jhalaniextrusion@yahoo.com

## DOOR SECTION

## ARCHITECTURAL

SEC. NO. : 8301

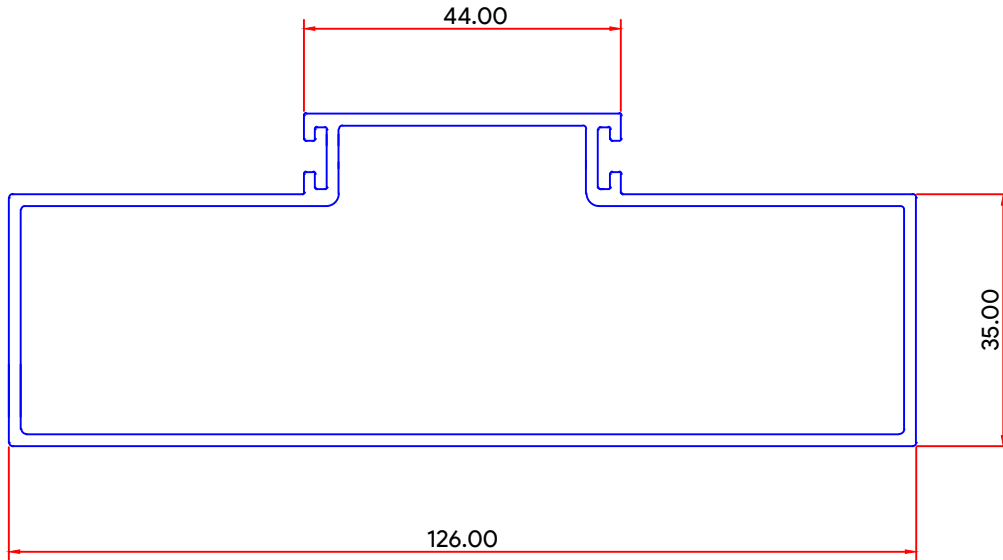

WEIGHT. : 5.800 KG / 12'

SEC. NO. : 8582

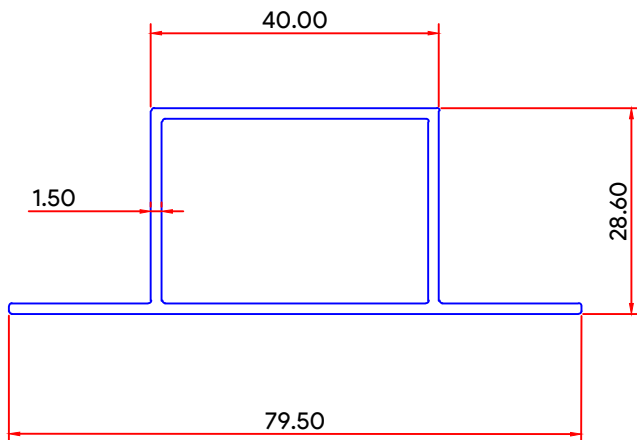

WEIGHT. : 2.530 KG / 12'

SEC. NO. : 8581

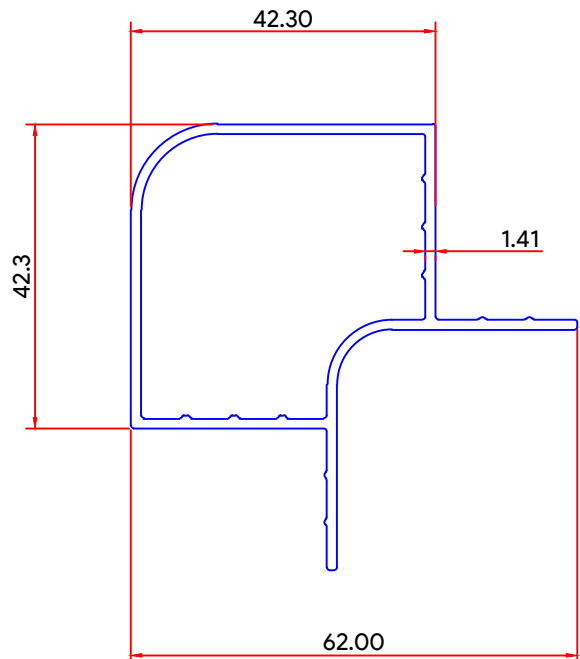

WEIGHT. : 2.725 KG / 12'



## DOOR SECTION

## ARCHITECTURAL

SEC. NO. : 6048-3

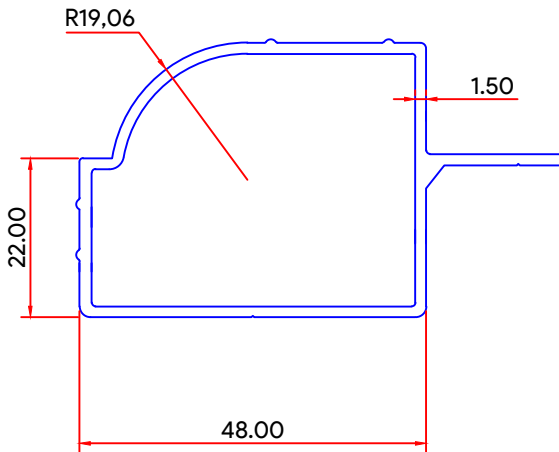

WEIGHT. : 2.743 KG / 12'

SEC. NO. : 6048-1

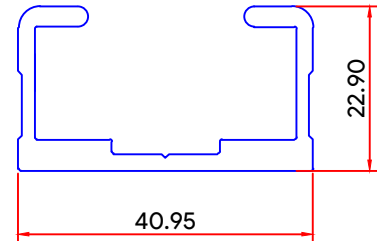

WEIGHT. : 2.574 KG / 12'

SEC. NO. : 8592

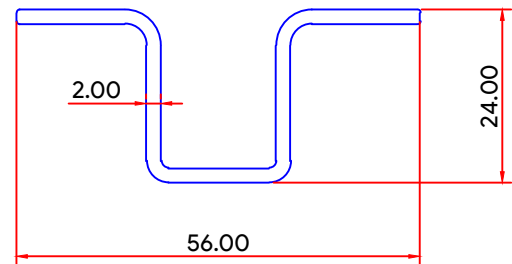

WEIGHT. : 1.872 KG / 12'

SEC. NO. : 6240

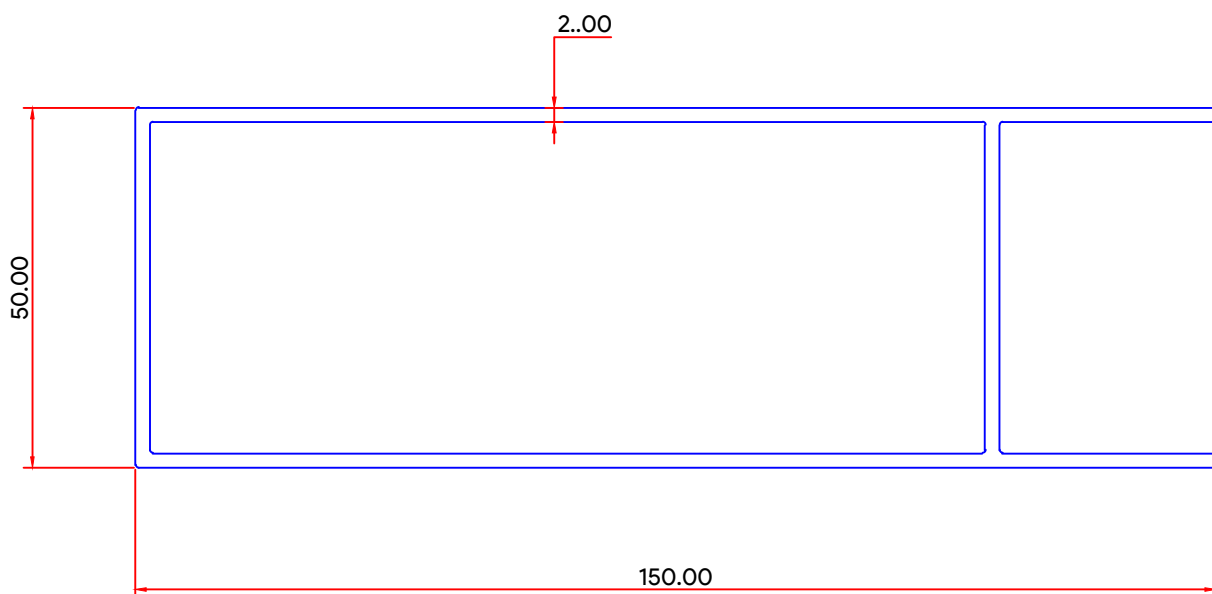

WEIGHT. : 7.747 KG / 12'



# JHALANI EXTRUSION

(A UNIT OF P.R.C.M. METAL)

C-36, Riico Industrial Area, Neemrana, District : Alwar, (Raj.) 301705  
Contact : 9716031516, 09953239231 E-Mail : jhalaniextrusion@yahoo.com

## DOOR SECTION

## ARCHITECTURAL

SEC. NO. : 6048-2

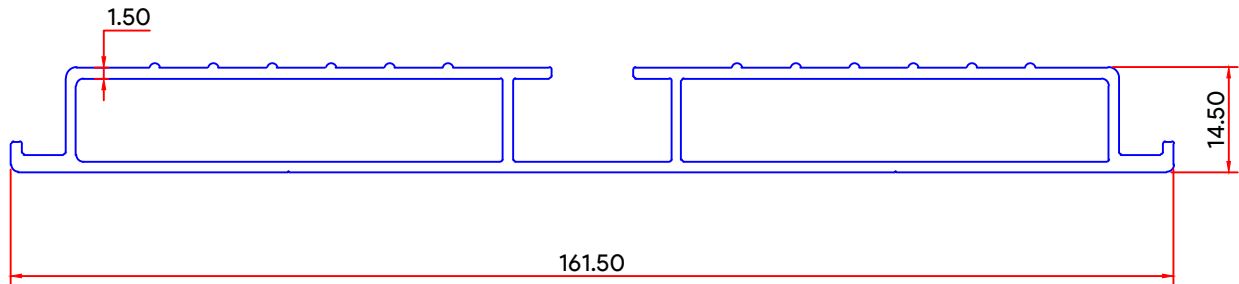

WEIGHT. : 5.218 KG / 12'

SEC. NO. : 6048-4

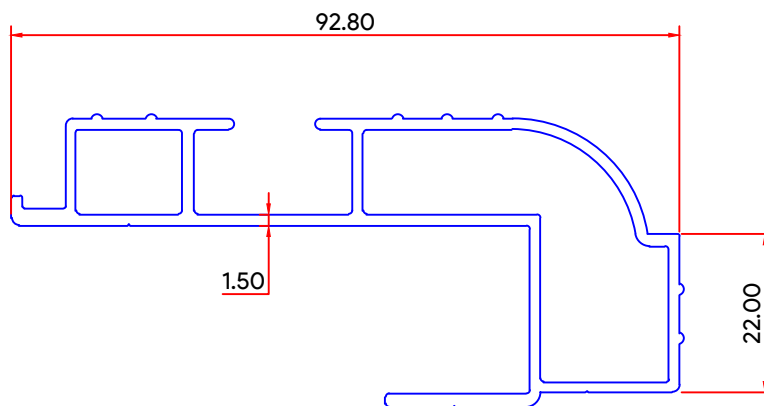

WEIGHT. : 4.321 KG / 12'



# JHALANI EXTRUSION

(A UNIT OF P.R.C.M. METAL)

C-36, Riico Industrial Area, Neemrana, District : Alwar, (Raj.) 301705  
Contact : 9716031516, 09953239231 E-Mail : jhalaniextrusion@yahoo.com

## DOOR SECTION

## ARCHITECTURAL

SEC. NO. : 6314

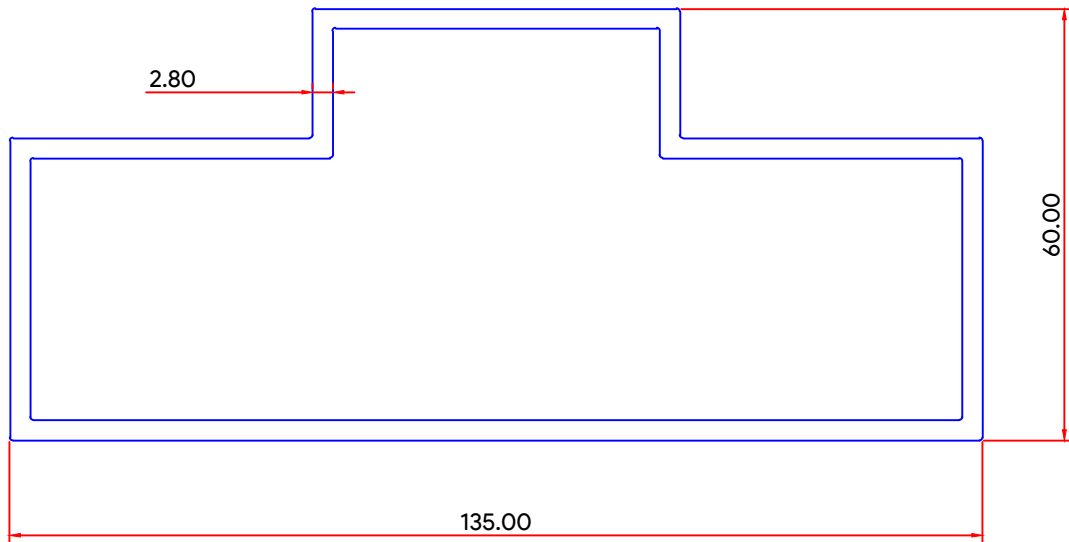

WEIGHT. : 10.481 KG / 12'