



DOMAL SECTION

ARCHITECTURAL

29 MM SERIES

SEC. NO. : 7460

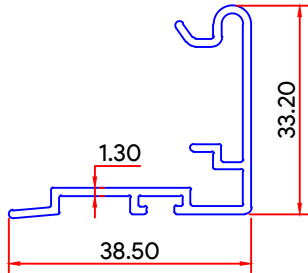

WEIGHT. : 1.365 KG / 12'

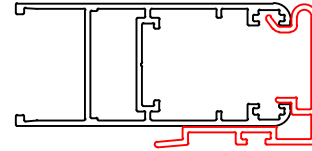

SECTION FITTING : 7460 & 7456

SEC. NO. : 7456

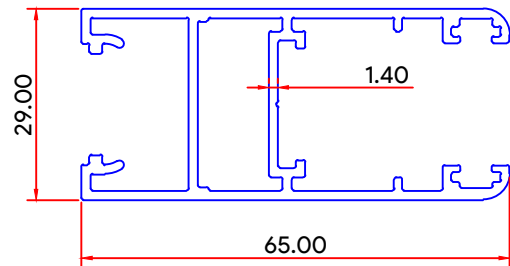

WEIGHT. : 3.310 KG / 12'

SEC. NO. : 7462

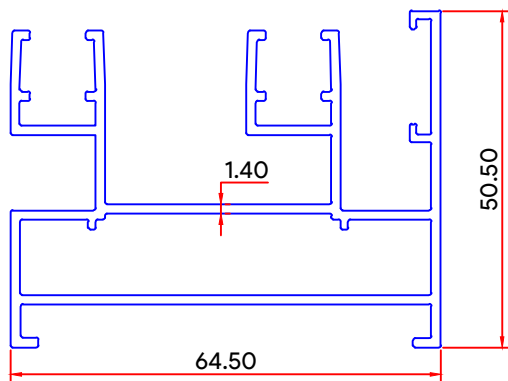

WEIGHT. : 4.550 KG / 12'

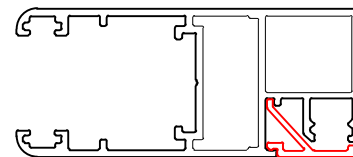

SECTION FITTING : 7463 & 7457

SEC. NO. : 7463

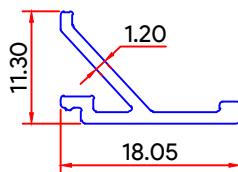

WEIGHT. : 0.410 KG / 12'

SEC. NO. : 7457

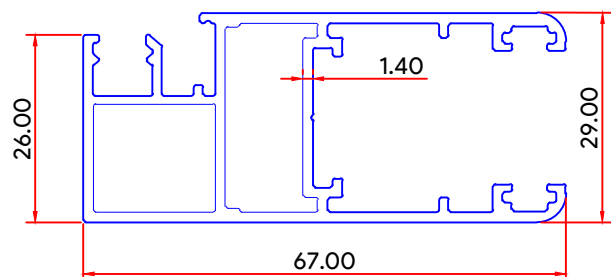

WEIGHT. : 3.510 KG / 12'



DOMAL SECTION

ARCHITECTURAL

29 MM SERIES

SEC. NO. : 7461

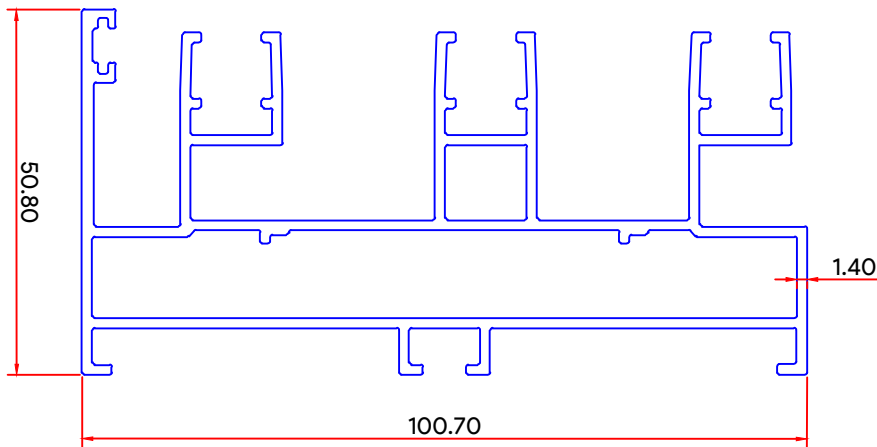

WEIGHT. : 6.860 KG / 12'

SEC. NO. : 8611

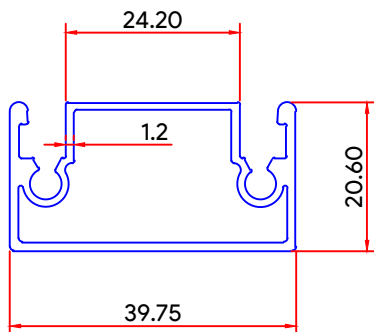

WEIGHT. : 1.825 KG / 12'

SEC. NO. : 8618

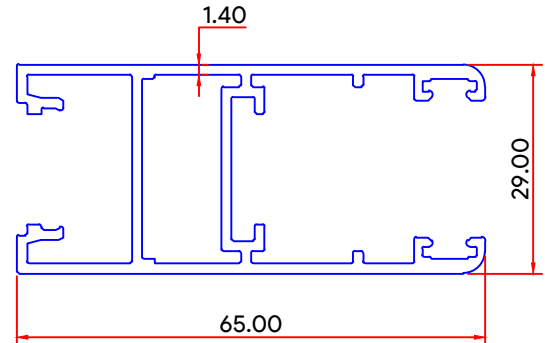

WEIGHT. : 3.350 KG / 12'

SEC. NO. : 7617

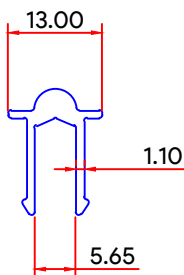

WEIGHT. : 0.613 KG / 12'

SEC. NO. : 8626

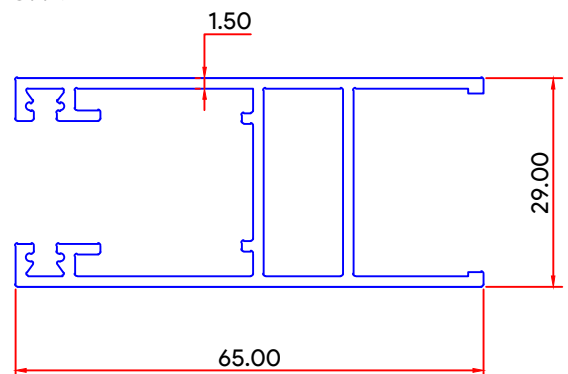

WEIGHT. : 3.239 KG / 12'



JHALANI EXTRUSION

(A UNIT OF P.R.C.M. METAL)

C-36, Riico Industrial Area, Neemrana, District : Alwar, (Raj.) 301705
Contact : 9716031516, 09953239231 E-Mail : jhalaniextrusion@yahoo.com

DOMAL SECTION

ARCHITECTURAL

SEC. NO. : JD-429

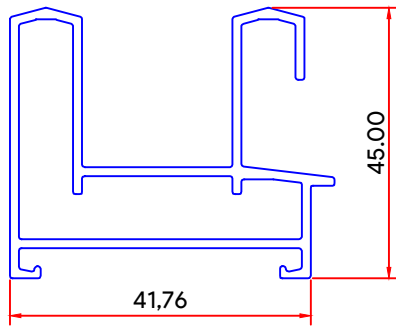

WEIGHT. : 2.80-3.00 KG / 12'

SEC. NO. : JD-426

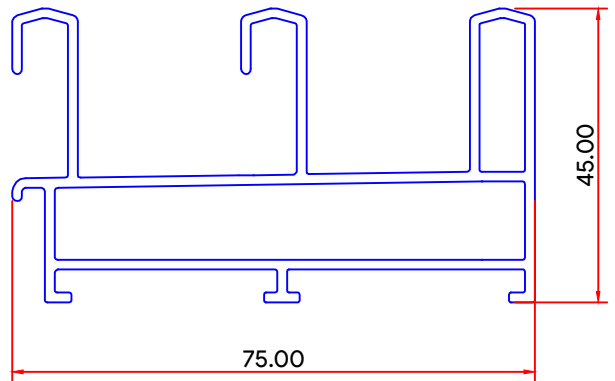

WEIGHT. : 4.20-4.40 KG / 12'

SEC. NO. : JD-425

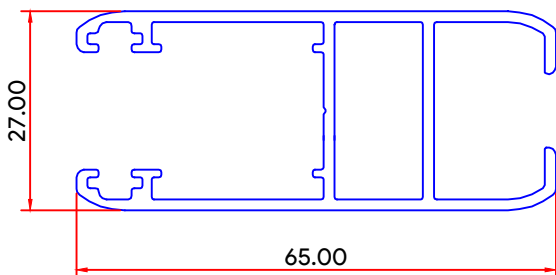

WEIGHT. : 3.00-3.20 KG / 12'

SEC. NO. : JD-430

FITTING WITH JD-425

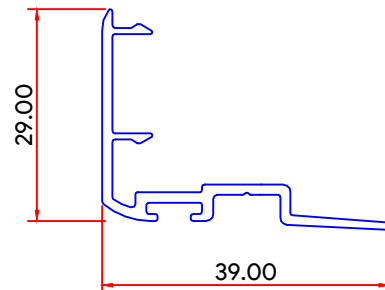

WEIGHT. : 1.10-1.30 KG / 12'

SEC. NO. : JE-425

FITTING WITH JD-428

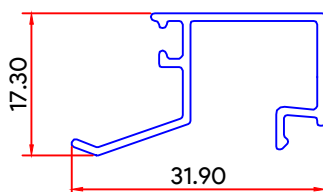

WEIGHT. : 0.850-0.900 KG / 12'



DOMAL SECTION (37 MM)

ARCHITECTURAL

SEC. NO. : 6211

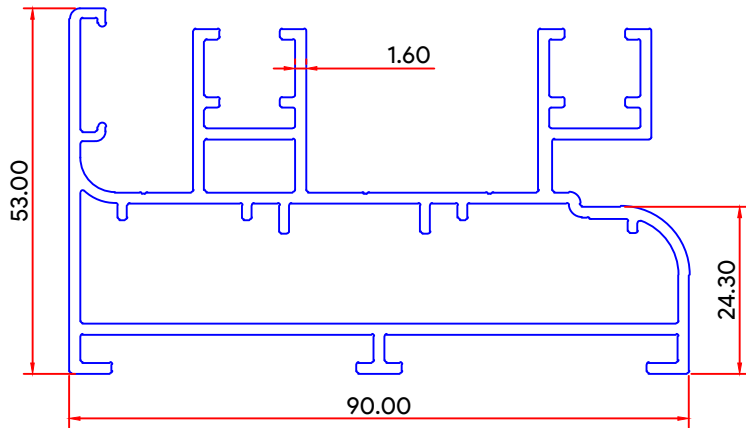

WEIGHT. : 8.930 KG / 16'

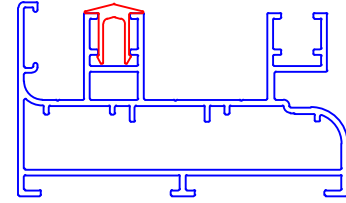

SECTION FITTING : 7503 & 6211 , 6212

SEC. NO. : 7503

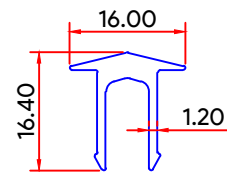

WEIGHT. : 0.872 KG / 16'

SEC. NO. : 6212

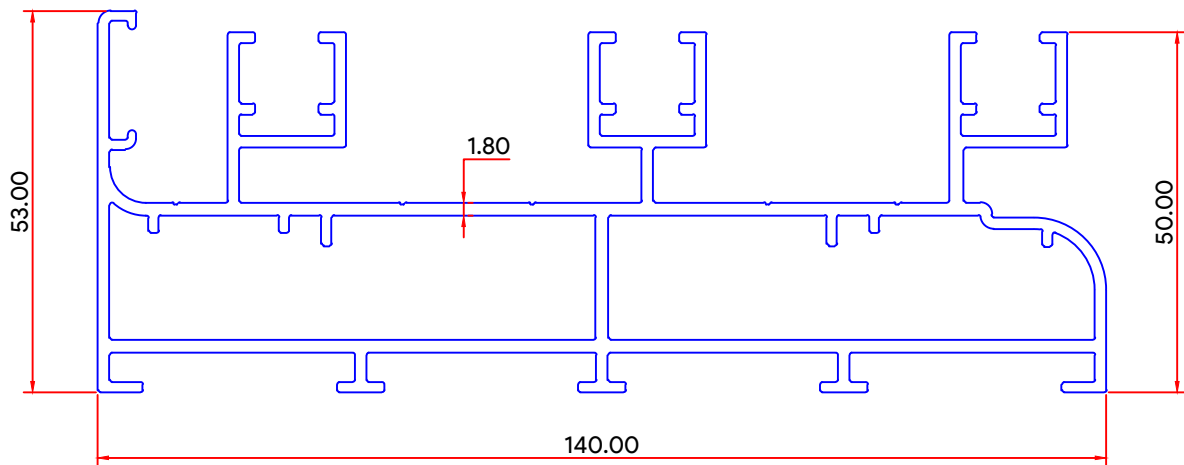

WEIGHT. : 13.500 KG / 16'

SEC. NO. : 6213

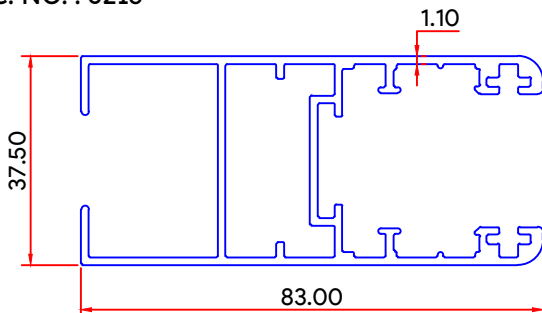

SEC. NO. : 6214

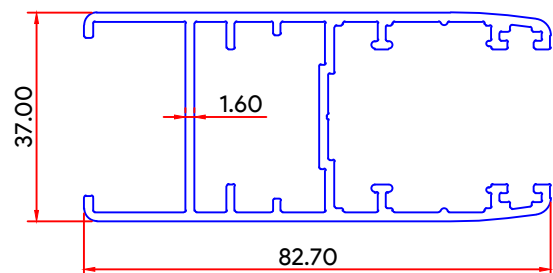

WEIGHT. : 6.130 KG / 16'



DOMAL SECTION (37 MM)

ARCHITECTURAL

SEC. NO. : 6215

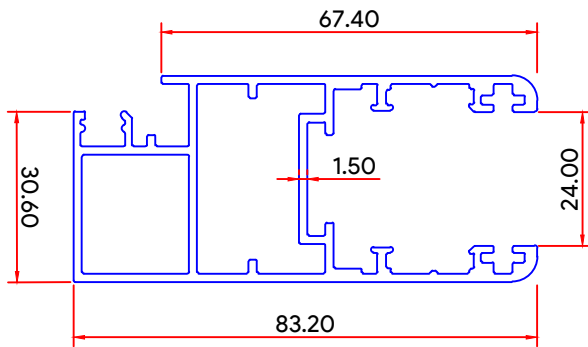

WEIGHT. : 7.000 KG / 16'

SEC. NO. : 6216

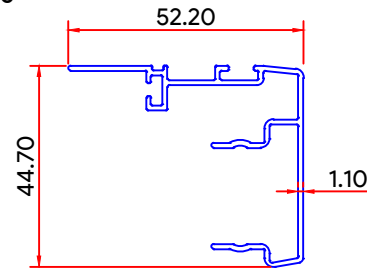

WEIGHT. : 2.350 KG / 16'

SEC. NO. : 7501

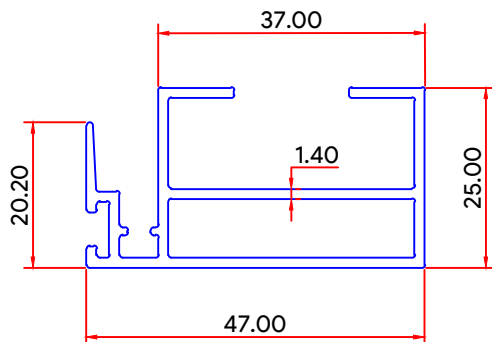

WEIGHT. : 2.375 KG / 16'

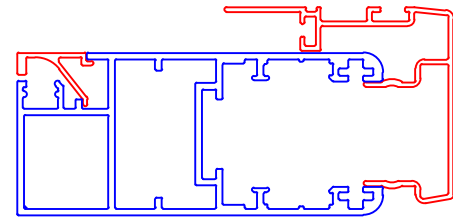

SECTION FITTING : 6215 & 6216 , 7502

SEC. NO. : 7502

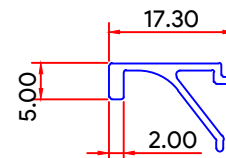

WEIGHT. : 0.560 KG / 16'



JHALANI EXTRUSION

(A UNIT OF P.R.C.M. METAL)

C-36, Riico Industrial Area, Neemrana, District : Alwar, (Raj.) 301705

Contact : 9716031516, 09953239231 E-Mail : jhalaniextrusion@yahoo.com

DOMAL SECTION

ARCHITECTURAL

SEC. NO. : 8635

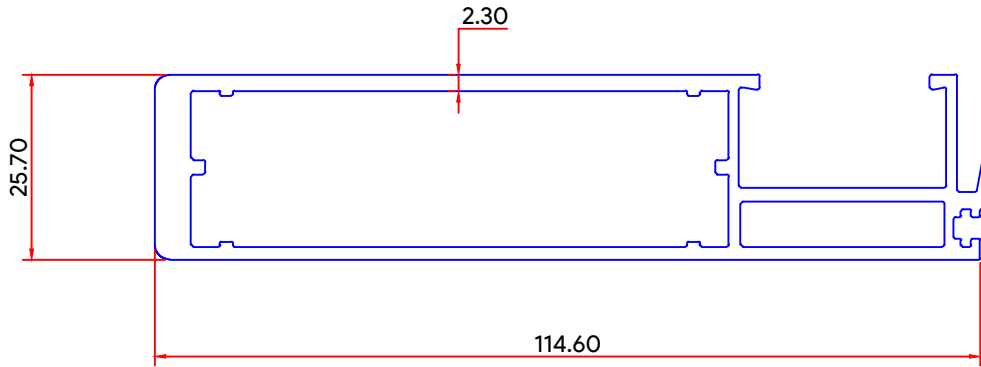

WEIGHT. : 6.565 KG / 12'

SEC. NO. : 8636

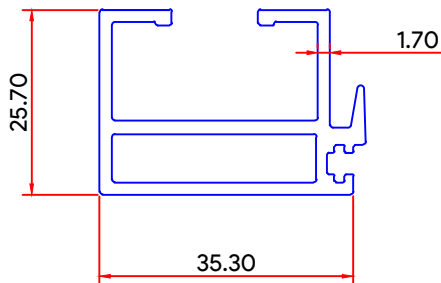

WEIGHT. : 2.480 KG / 12'