

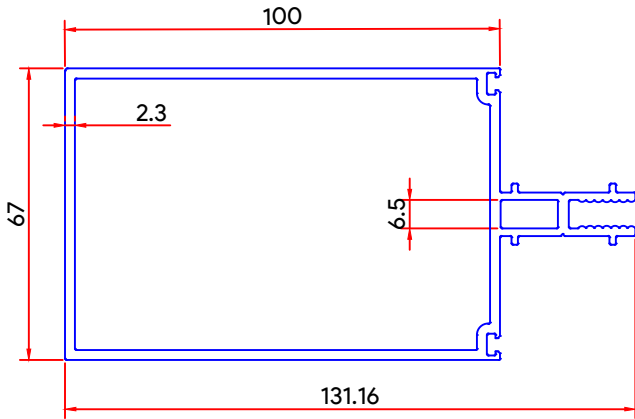

CURTAIN WALL SECTION

ARCHITECTURAL

SEC. NO. : 6016



WEIGHT : 8.900 KG / 12'

SEC. NO. : 6009

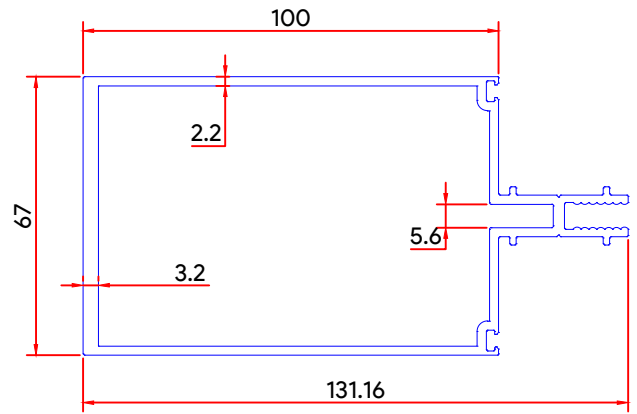

WEIGHT : 9.520 KG / 12'

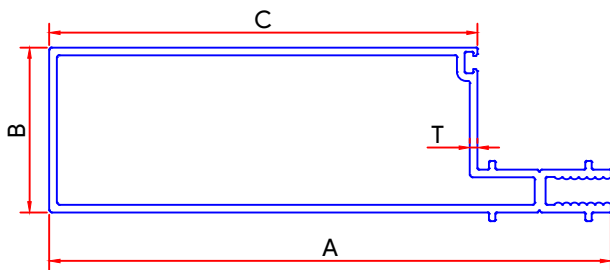

SEC. NO.	A	B	C	T	WEIGHT/12'
6018	131.16	38.00	100	1.80	6.180
6014	131.16	38.50	100	2.00	6.910

SEC. NO. : 6017

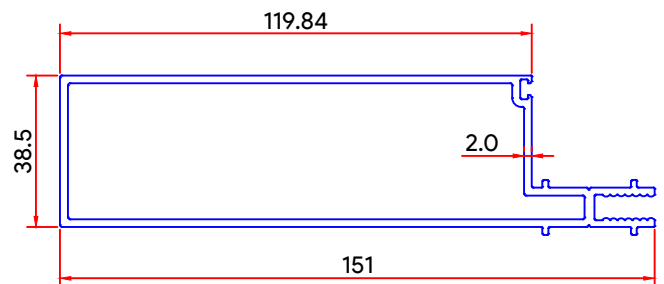

WEIGHT : 7.500 KG / 12'

SEC. NO. : 6033

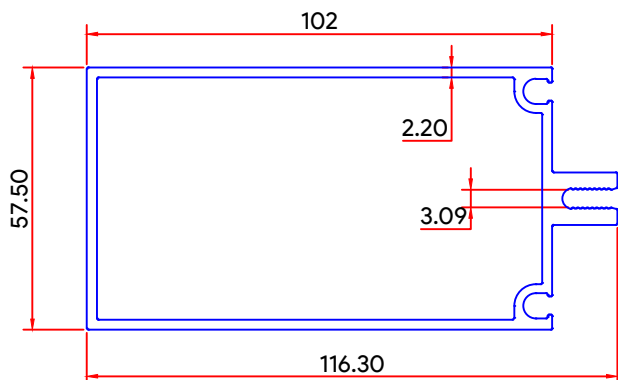

WEIGHT : 8.130 KG / 12'

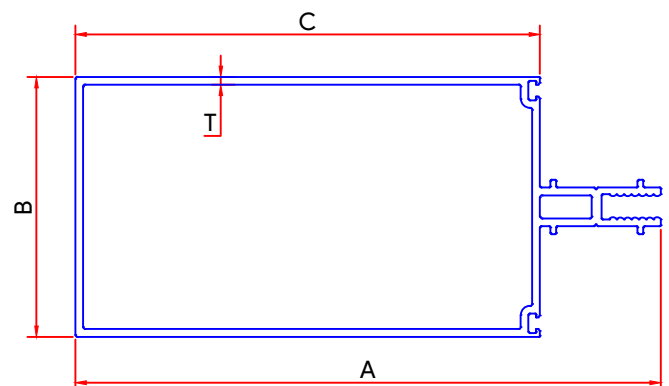

SEC. NO.	A	B	C	T	WEIGHT/12'
6020	151.00	67.00	119.84	2.00	8.800
6020	151.00	67.00	119.84	2.80	11.500



CURTAIN WALL SECTION

ARCHITECTURAL

SEC. NO. : 6021

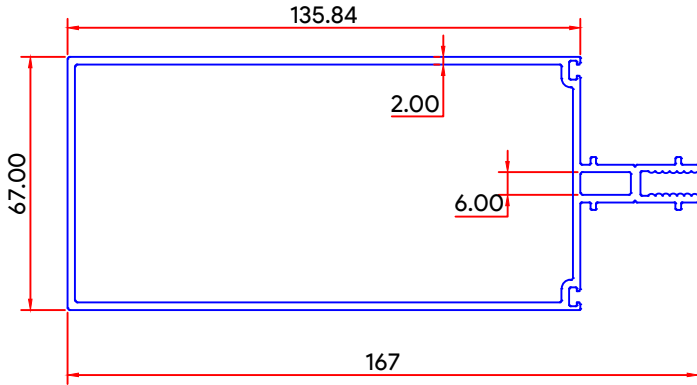

WEIGHT : 9.440 KG / 12'

SEC. NO. : 6019

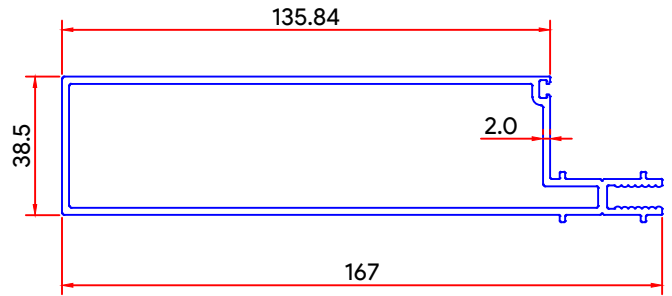

WEIGHT : 8.160 KG / 12'

SEC. NO. : 6036

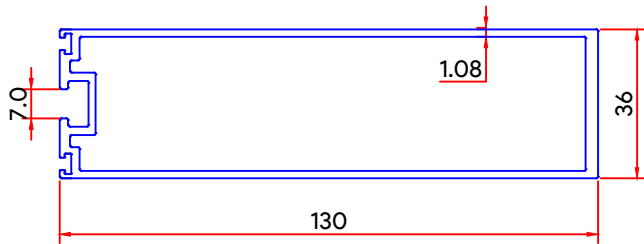

WEIGHT : 6.650 KG / 12'

SEC. NO. : 8356

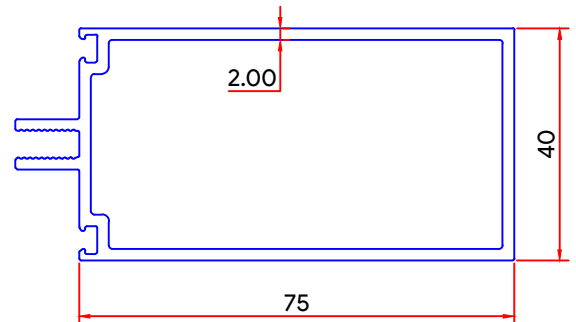

WEIGHT : 4.910 KG / 12'

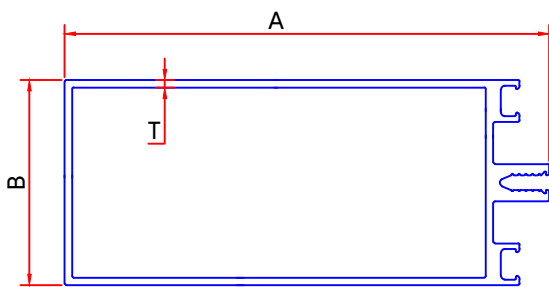

SEC. NO. : 6067

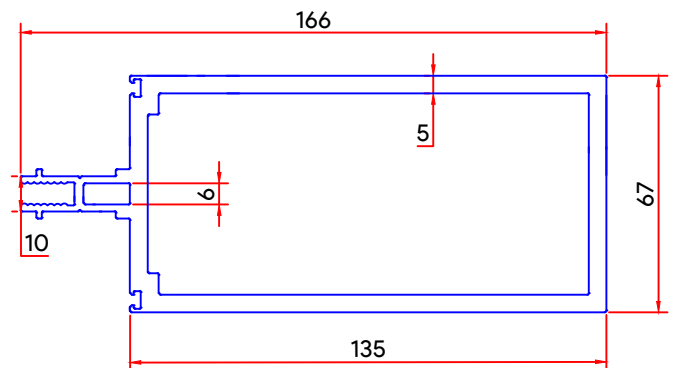

WEIGHT : 20.690 KG / 12'

SEC. NO.	A	B	T	WEIGHT/12'
NS-36	130.02	55	2.00	8.319
5560	104	55	1.80	6.70-7.0
5561	104	55	3.00	9.80-10.20
5562	104	55	4.00	13.80-14.20



CURTAIN WALL SECTION

ARCHITECTURAL

SEC. NO. : 6072

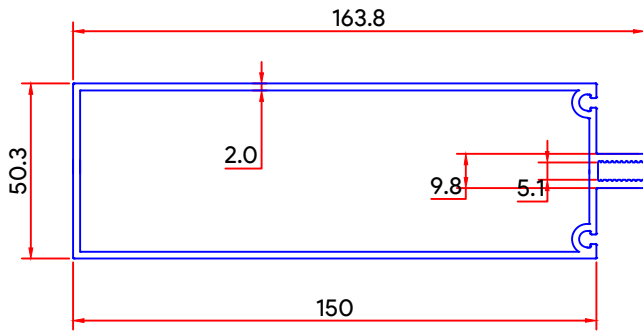

WEIGHT : 8.700 KG / 12'

SEC. NO. : 8051

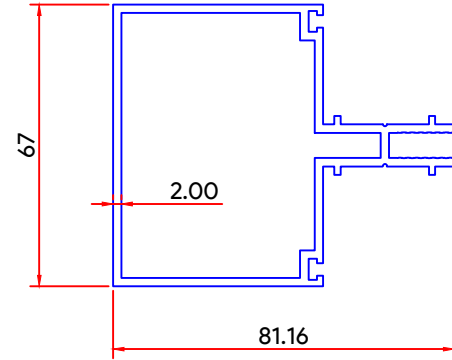

WEIGHT : 5.973 KG / 12'

SEC. NO. : NS-35

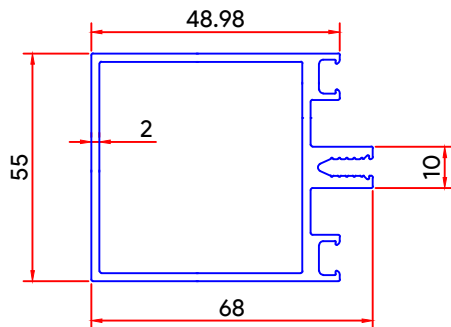

WEIGHT : 5.868 KG / 12'

SEC. NO. : 8509

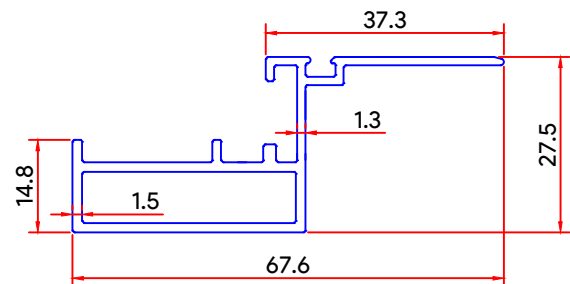

WEIGHT : 2.230 KG / 12'

SEC. NO. : 8117

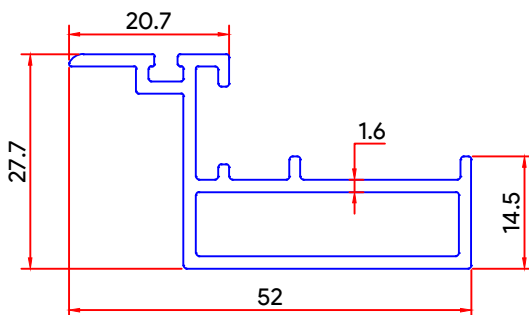

WEIGHT : 2.200 KG / 12'

SEC. NO. : 13110

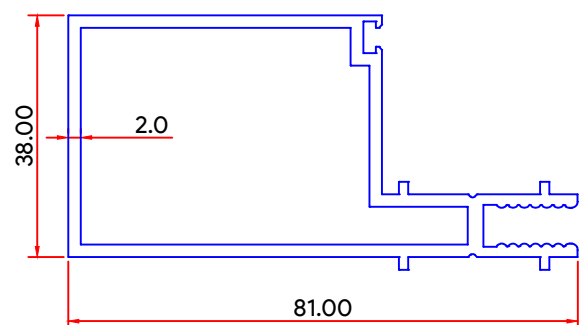

WEIGHT : 4.900 KG / 12'



CURTAIN WALL SECTION

ARCHITECTURAL

SEC. NO. : 6012

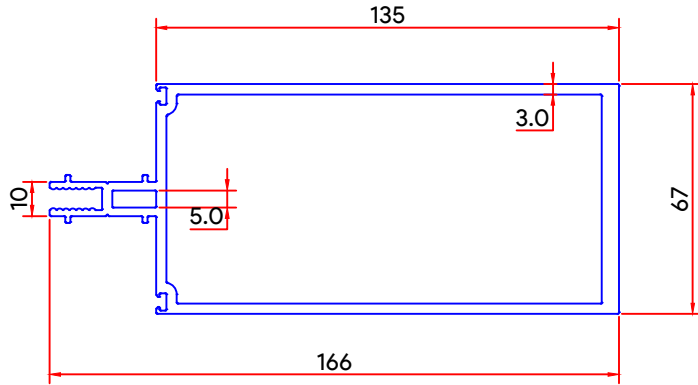

WEIGHT : 14.500 KG / 12'

SEC. NO. : 6013

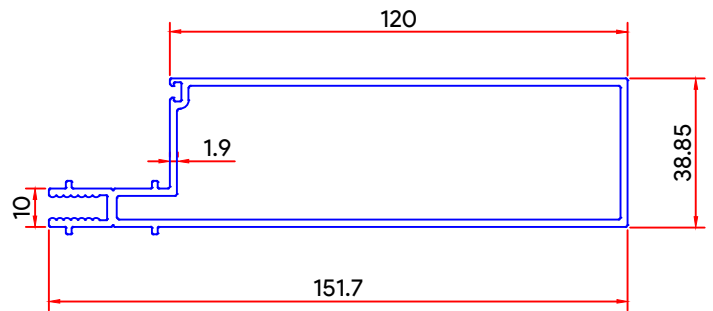

WEIGHT : 7.250 KG / 12'

SEC. NO. : 6015

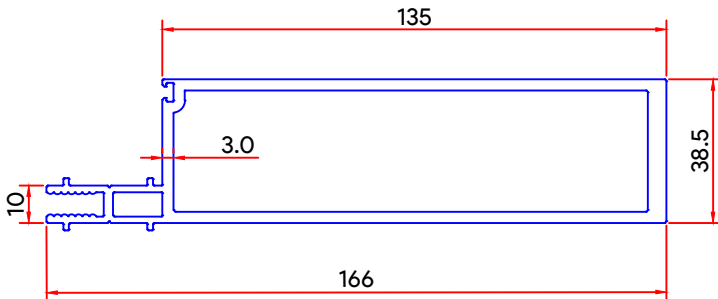

WEIGHT : 12.040 KG / 12'

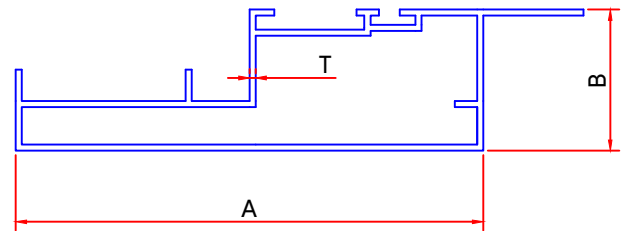

SEC. NO.	A	B	T	WEIGHT/12'
JE-251	91.00	25.00	1.20	2.80-3.00
JE-252	82.81	27.50	1.40	3.0-3.20

SEC. NO. : 7078

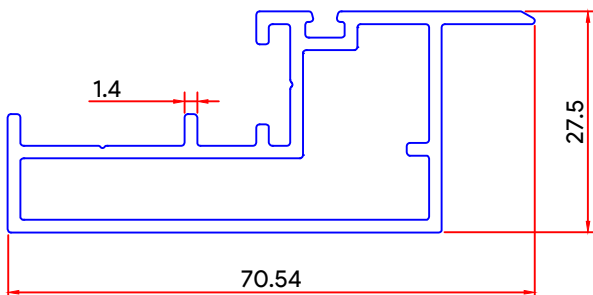

WEIGHT : 2.750 KG / 12'

SEC. NO. : JE-255

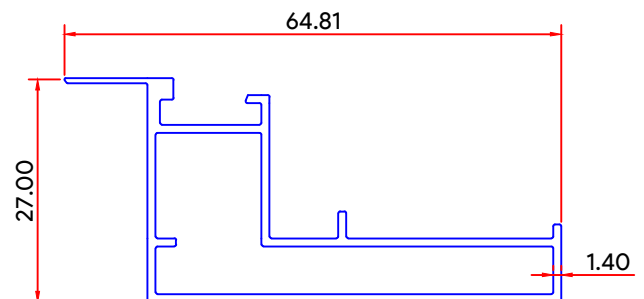

WEIGHT : 2.5-2.8 KG / 12'



CURTAIN WALL SECTION

ARCHITECTURAL

SEC. NO. : 8423

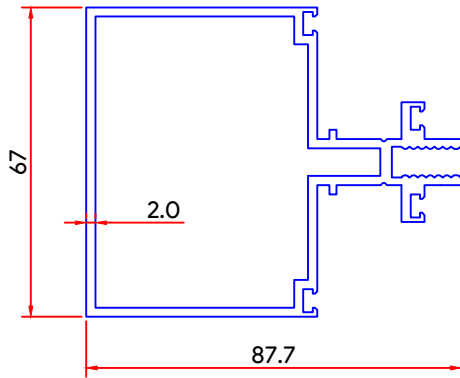

WEIGHT : 6.950 KG / 12'

SEC. NO. : 8424

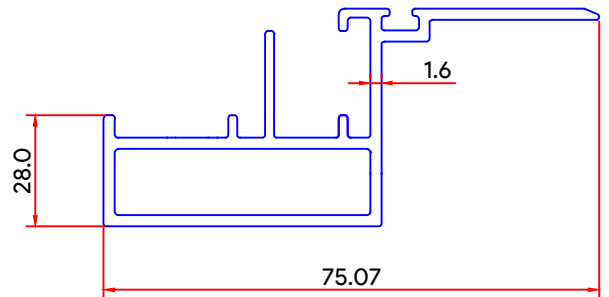

WEIGHT : 2.950 KG / 12'

SEC. NO. : 7079

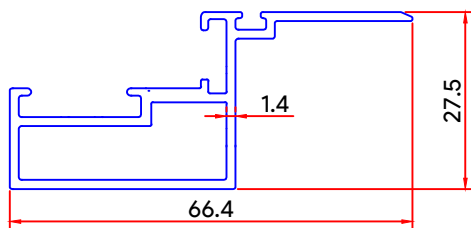

WEIGHT : 2.350 KG / 12'

SEC. NO. : NS-28

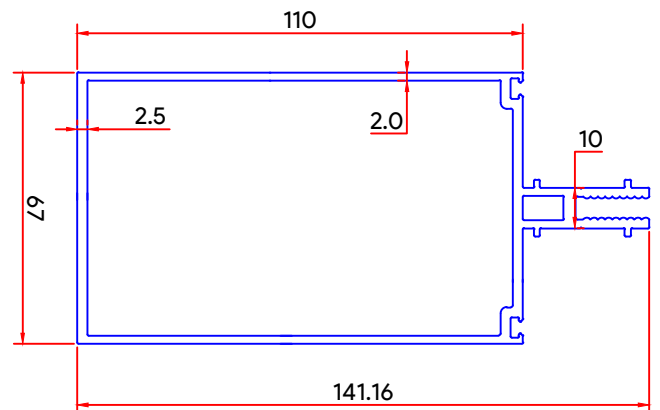

WEIGHT : 9.298 KG / 12'

SEC. NO. : 7153

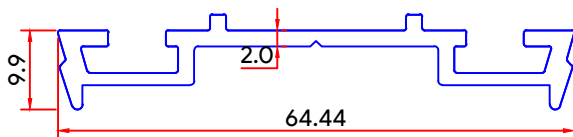

WEIGHT : 1.940 KG / 12'

SEC. NO. : NS-13

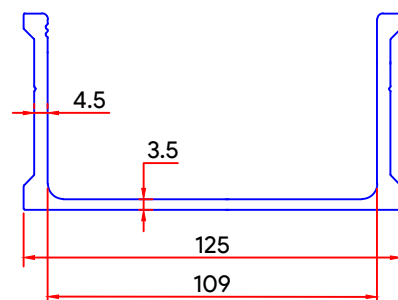

WEIGHT : 10.752 KG / 12'

SEC. NO. : 7154

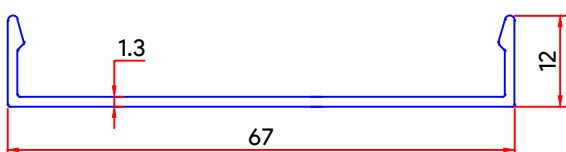

WEIGHT : 1.160 KG / 12'



CURTAIN WALL SECTION

ARCHITECTURAL

SEC. NO. : 14500

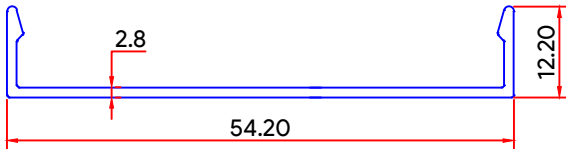

WEIGHT : 1.00-1.10 KG / 12'

SEC. NO. : 14510

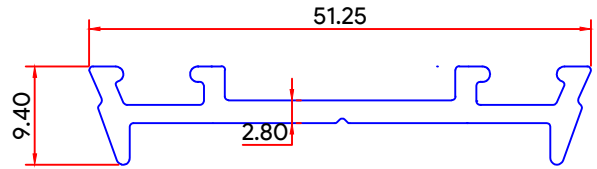

WEIGHT : 1.70-1.90 KG / 12'

SEC. NO. : NS-40

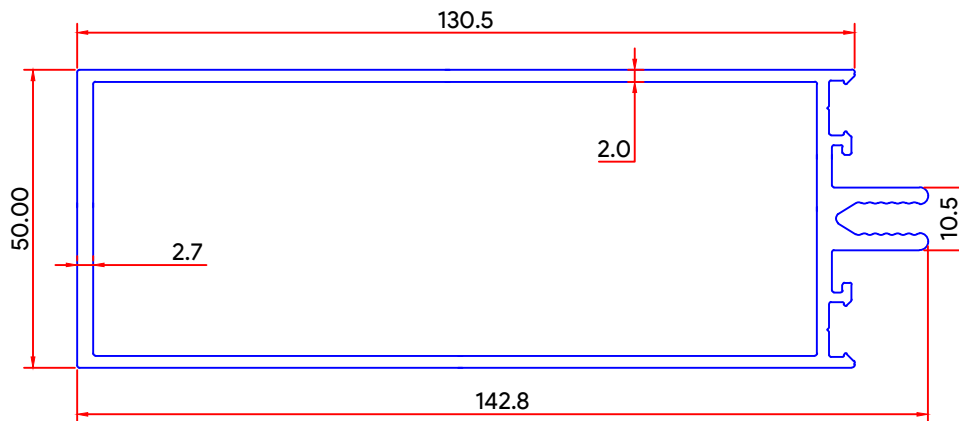

WEIGHT : 8.511 KG / 12'

SEC. NO. : 6098

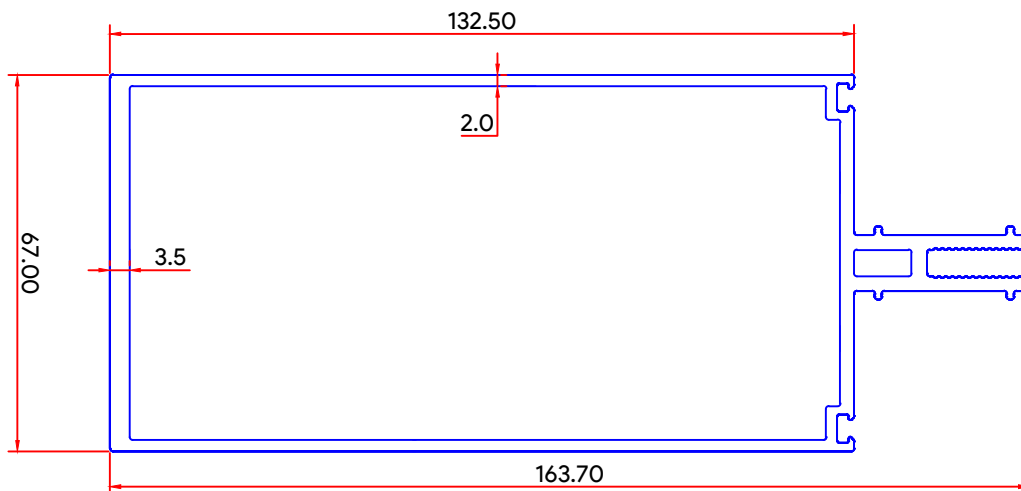

WEIGHT : 10.795 KG / 12'



CURTAIN WALL SECTION

ARCHITECTURAL

SEC. NO. : 6108

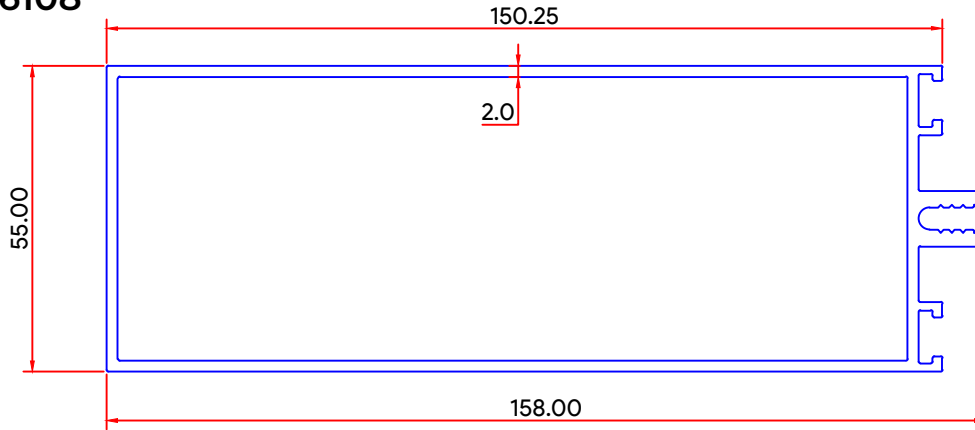

WEIGHT : 8.800 KG / 12'

SEC. NO. : 6117

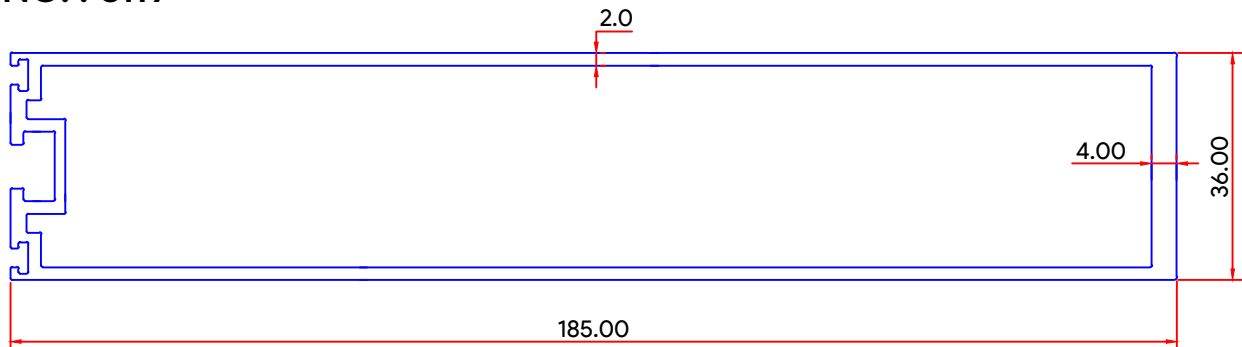

WEIGHT : 9.625 KG / 12'

SEC. NO. : 6122

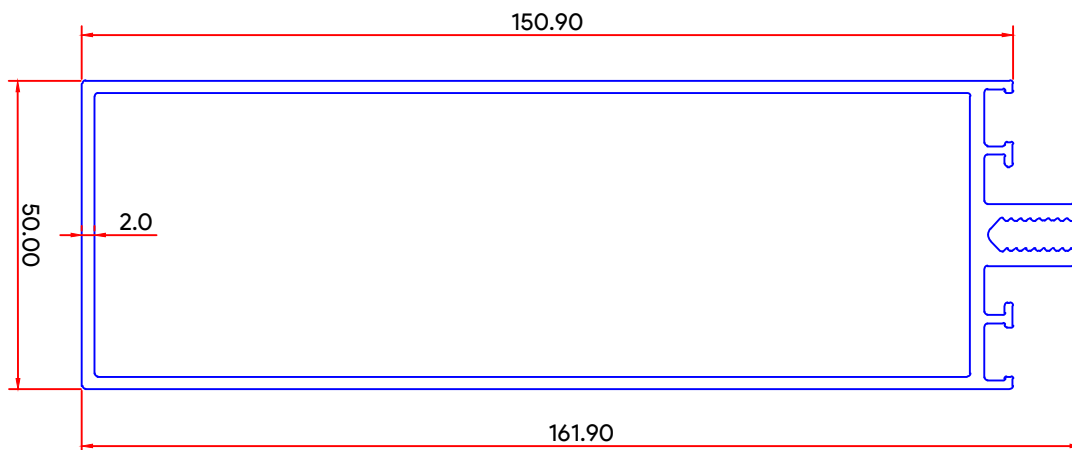

WEIGHT : 8.915 KG / 12'



CURTAIN WALL SECTION

ARCHITECTURAL

SEC. NO. : 6118

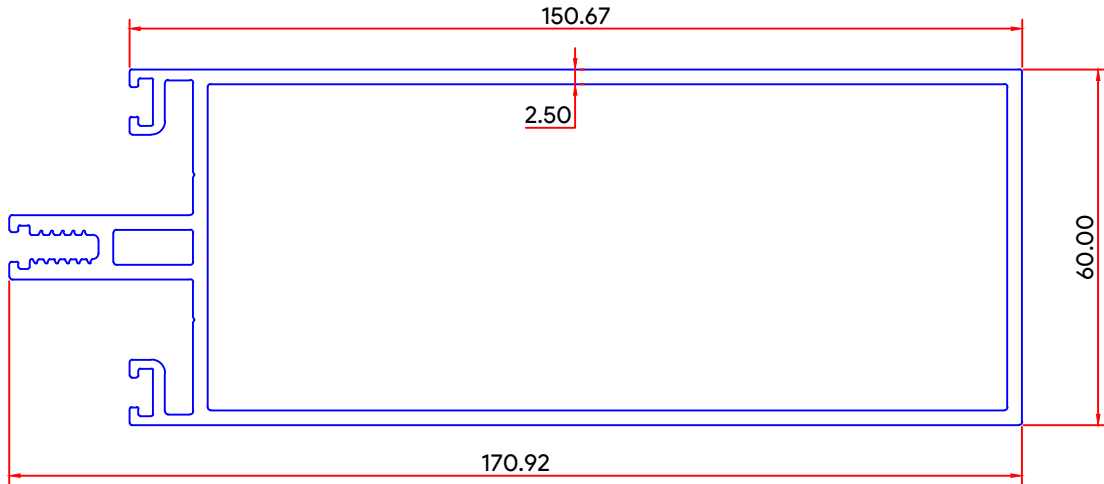

WEIGHT : 12.365 KG / 12'

SEC. NO. : 6134

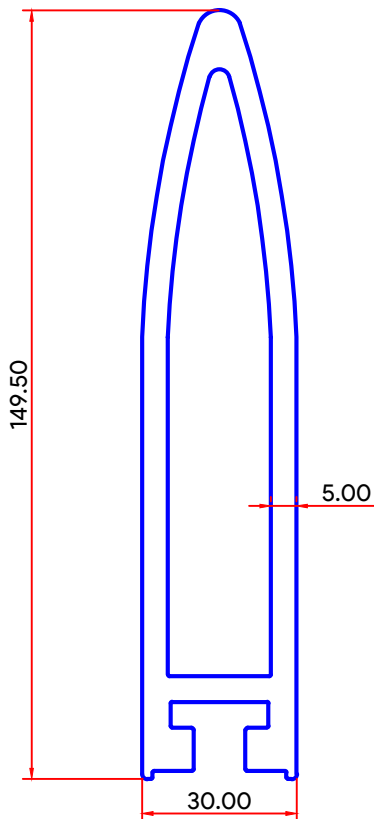

WEIGHT : 16.587 KG / 12'

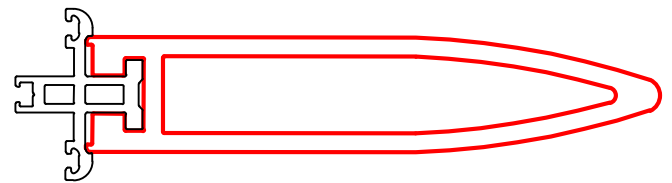

SECTION FITTING : 6134 & 6135

SEC. NO. : 6135

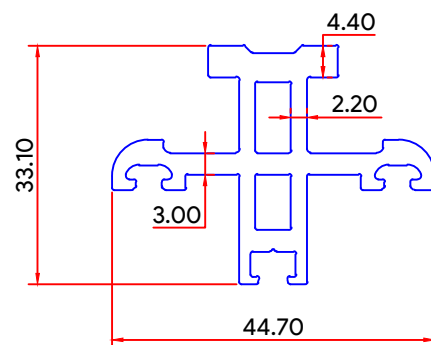

WEIGHT : 3.560 KG / 12'



CURTAIN WALL SECTION

ARCHITECTURAL

SEC. NO. : 6146

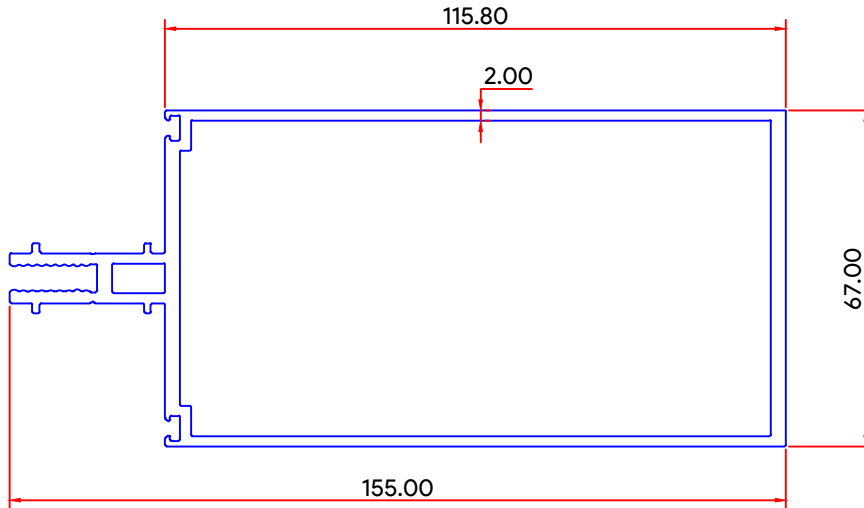

WEIGHT : 10.320 KG / 12'

SEC. NO. : 6154

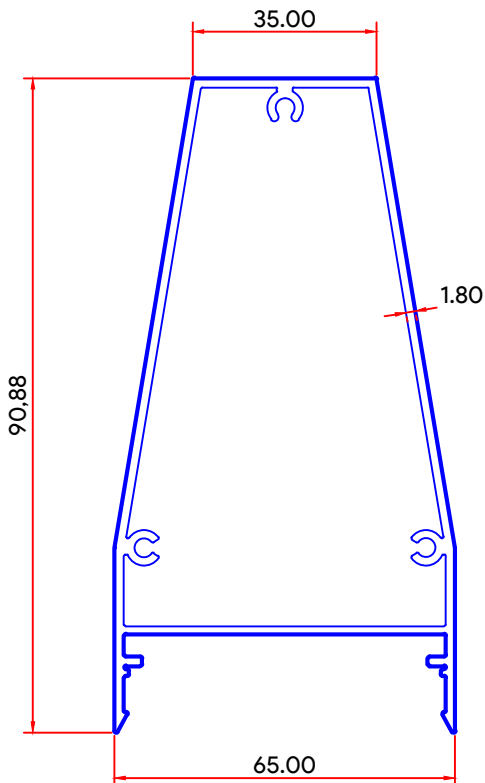

WEIGHT. : 6.765 KG / 12'

SEC. NO. : 7434

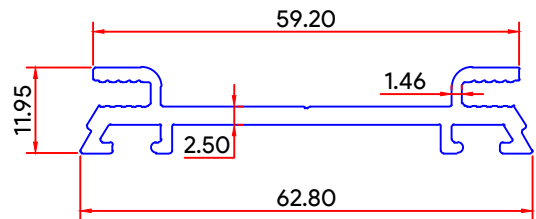

WEIGHT. : 2.300 KG / 12'

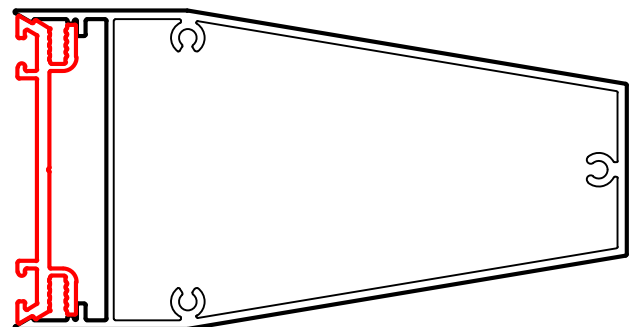

SECTION FITTING : 7434 & 6154



CURTAIN WALL SECTION

ARCHITECTURAL

SEC. NO. : 6068

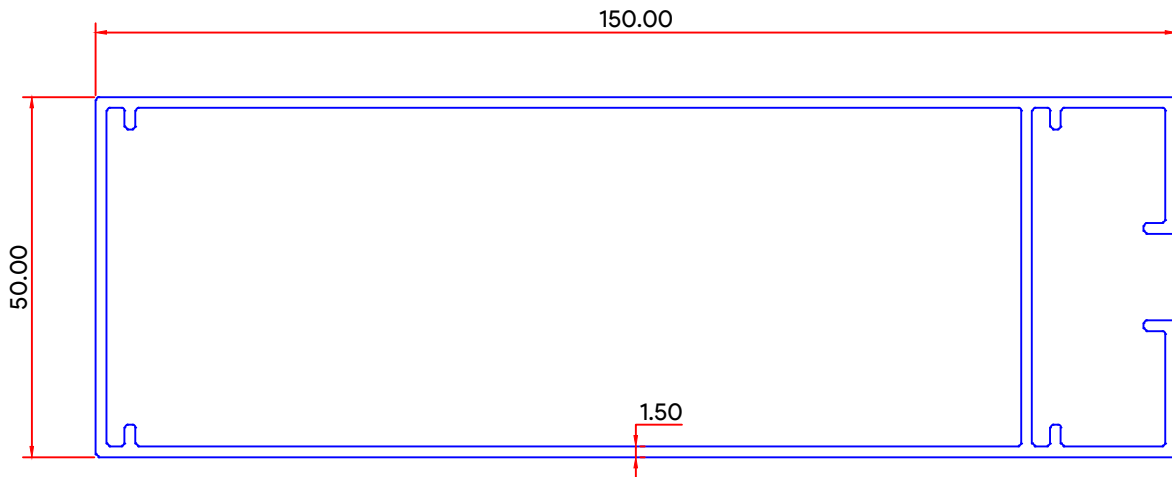

WEIGHT. : 6.625 KG / 12'

SEC. NO. : 6037

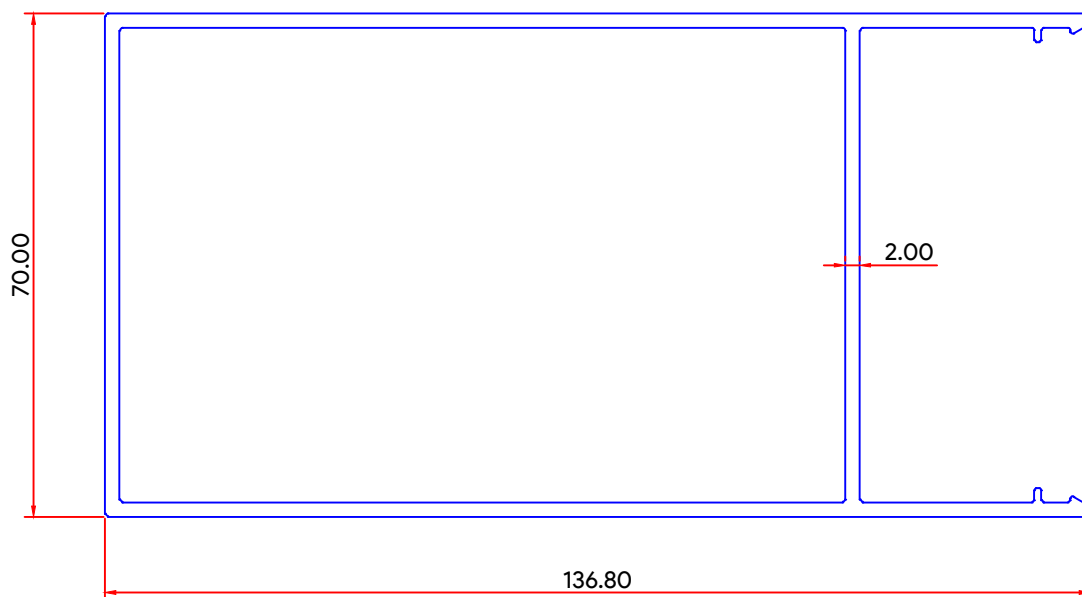

WEIGHT. : 8.070 KG / 12'



CURTAIN WALL SECTION

ARCHITECTURAL

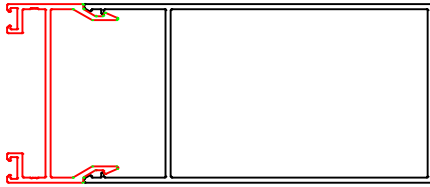

SECTION FITTING : **7338** & 6037

SEC. NO. : 7338

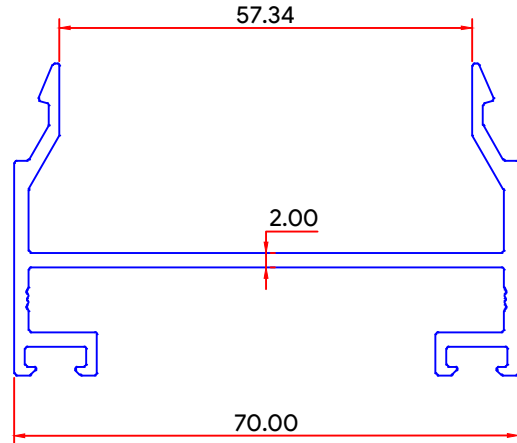

WEIGHT. : 3.600 KG / 12'

SEC. NO. : 6140

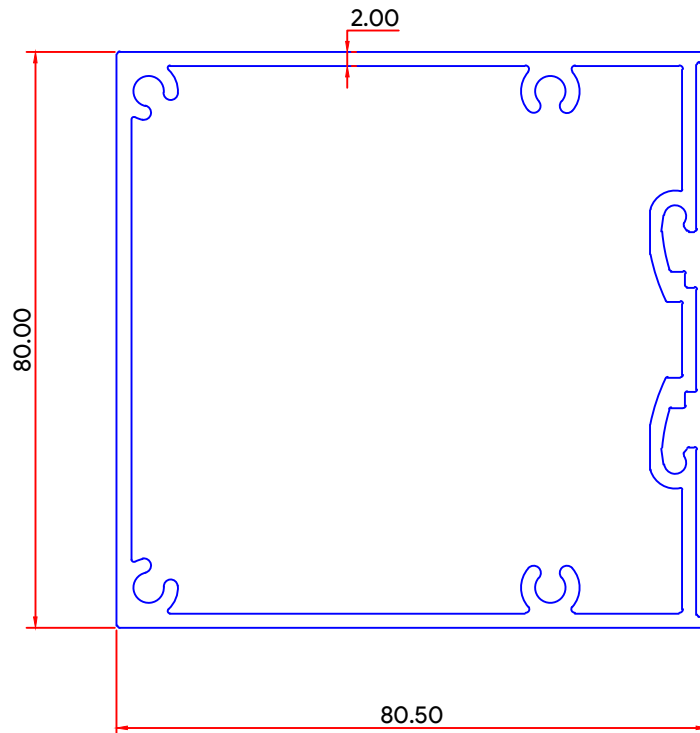

WEIGHT. : 7.680 KG / 12'



CURTAIN WALL SECTION

ARCHITECTURAL

SEC. NO. : 6141

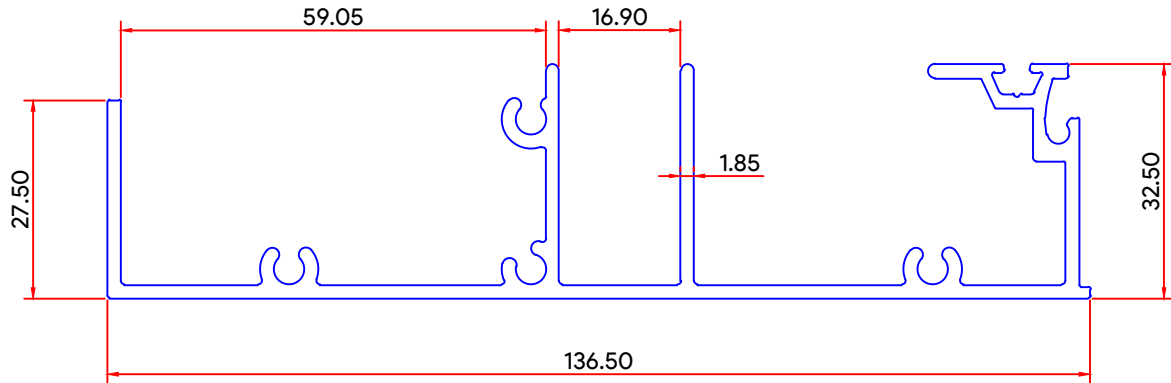

WEIGHT. : 5.975 KG / 12'

SEC. NO. : 6142

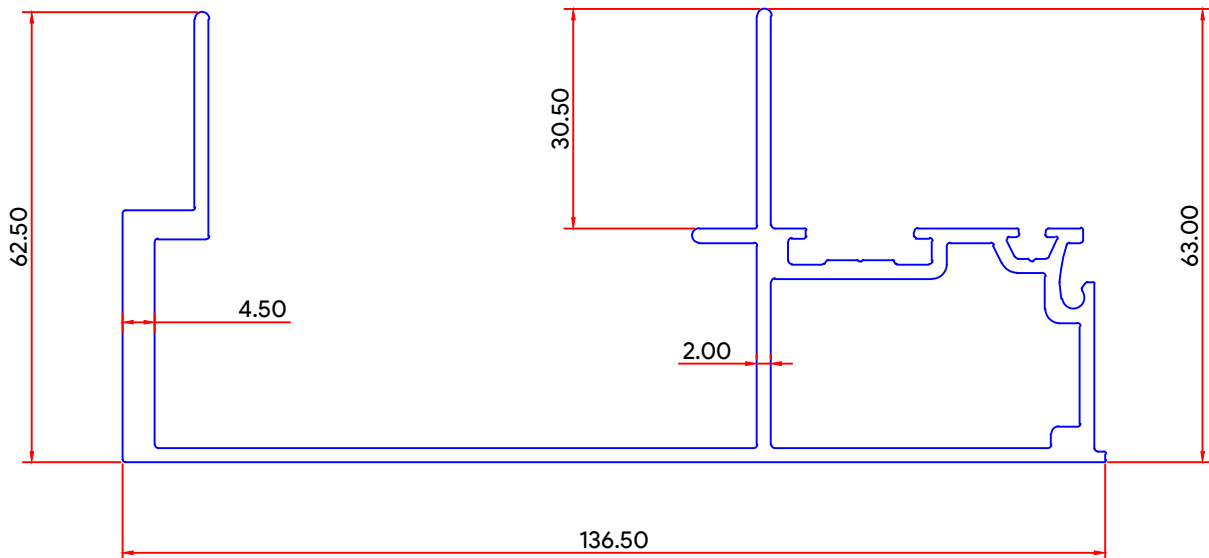

WEIGHT. : 8.460 KG / 12'



CURTAIN WALL SECTION

ARCHITECTURAL

SEC. NO. : 6143

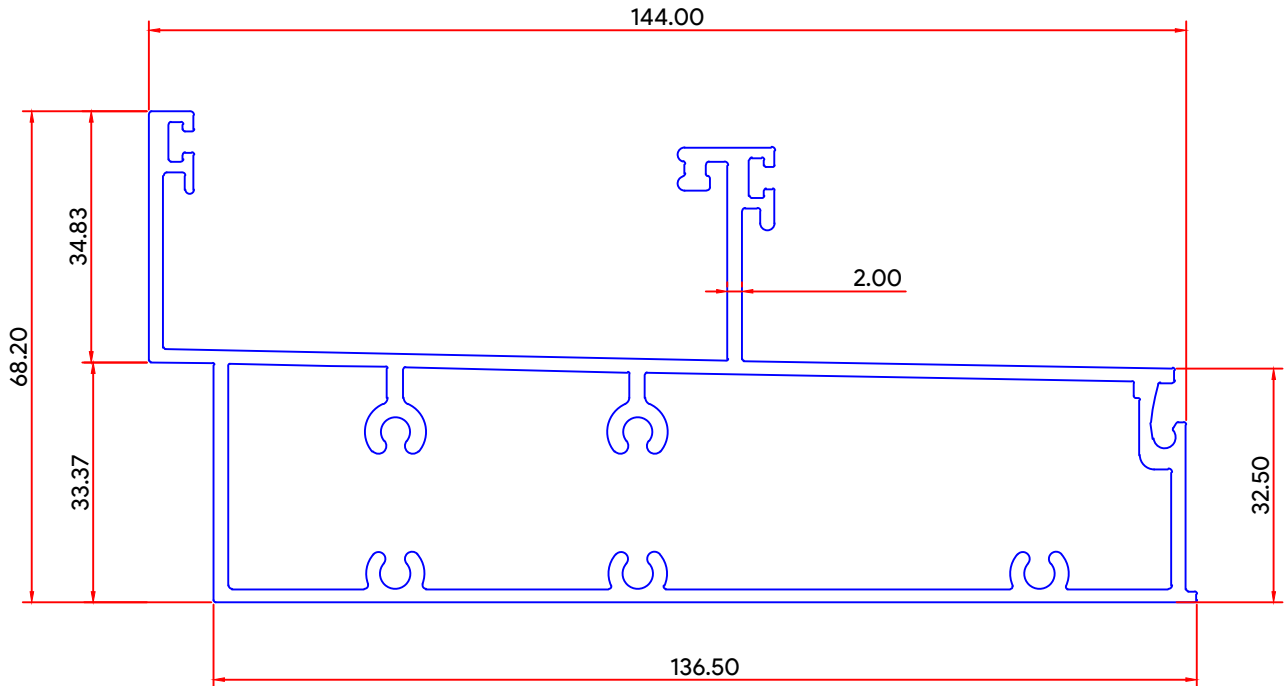

WEIGHT. : 10.040 KG / 12'

SEC. NO. : 6144

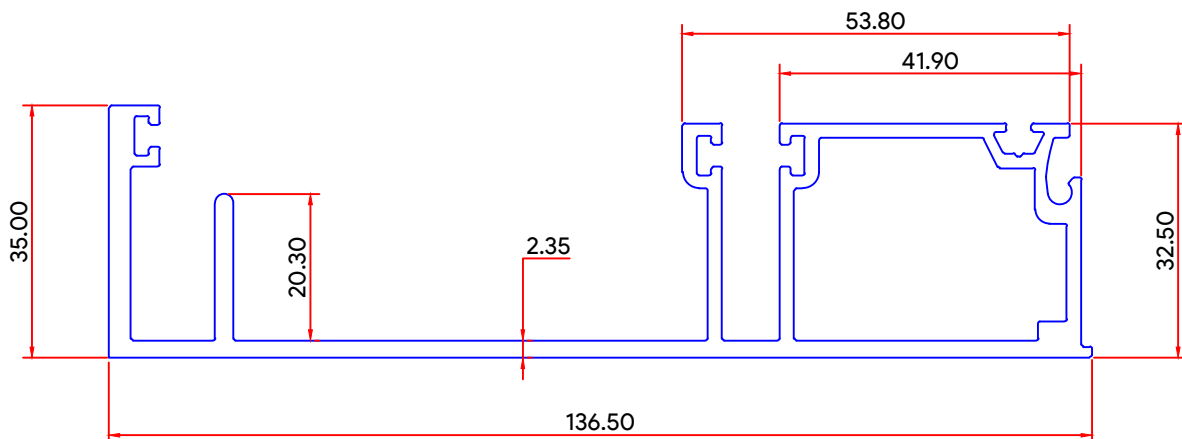

WEIGHT. : 7.840 KG / 12'



CURTAIN WALL SECTION

ARCHITECTURAL

SEC. NO. : 6194

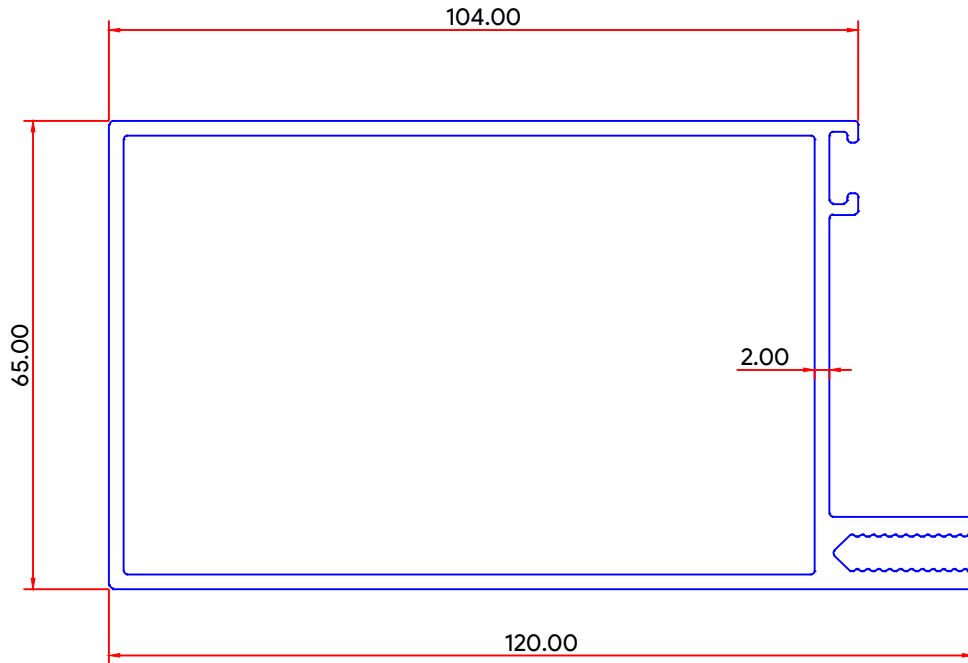

WEIGHT. : 7.622 KG / 12'

SEC. NO. : 6193

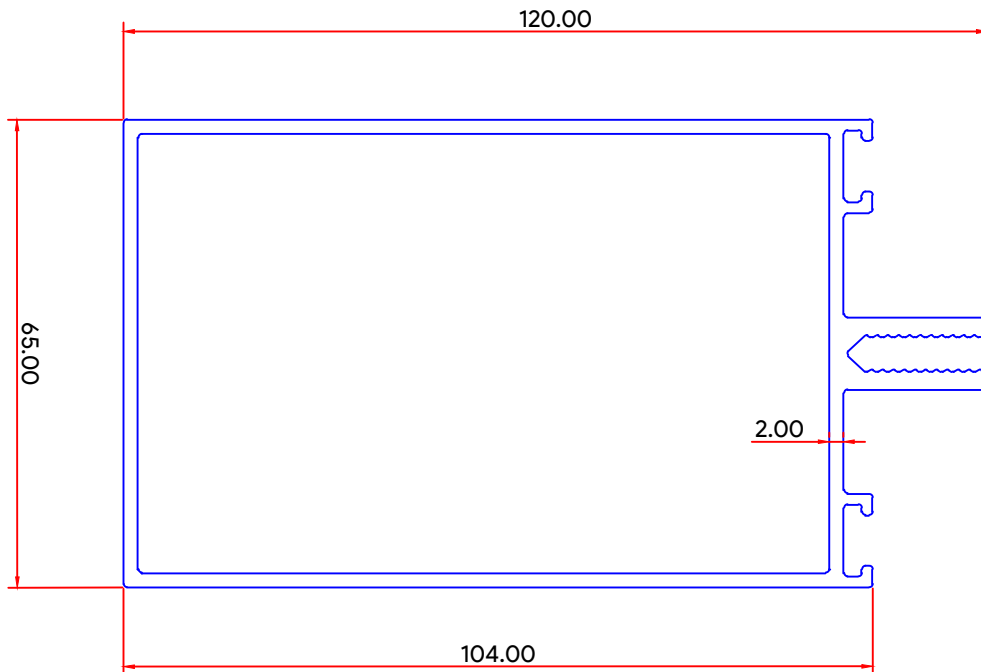

WEIGHT. : 7.785 KG / 12'



CURTAIN WALL SECTION

ARCHITECTURAL

SEC. NO. : 6203

JINDAL SEC. NO. : S6457

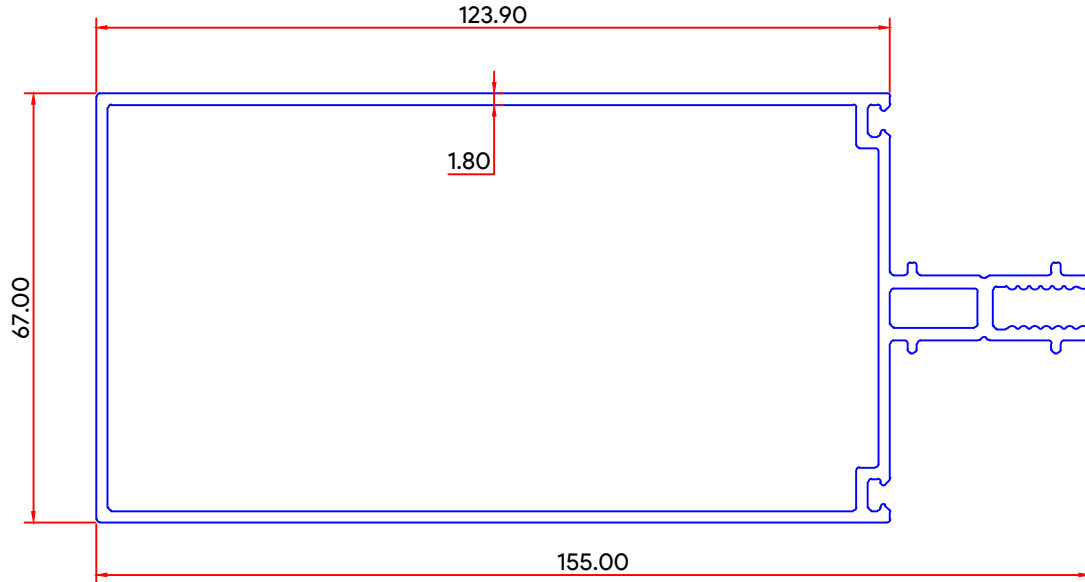

WEIGHT. : 8.297 KG / 12'

SEC. NO. : 6204

JINDAL SEC. NO. : 35504

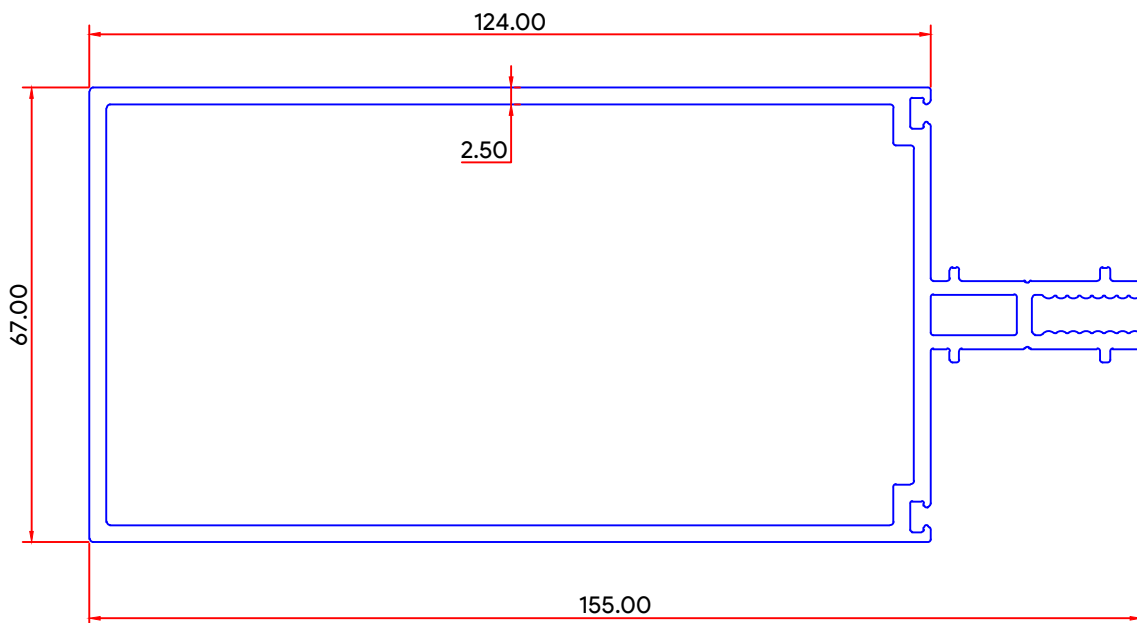

WEIGHT. : 10.909 KG / 12'



CURTAIN WALL SECTION

ARCHITECTURAL

SEC. NO. : 6209

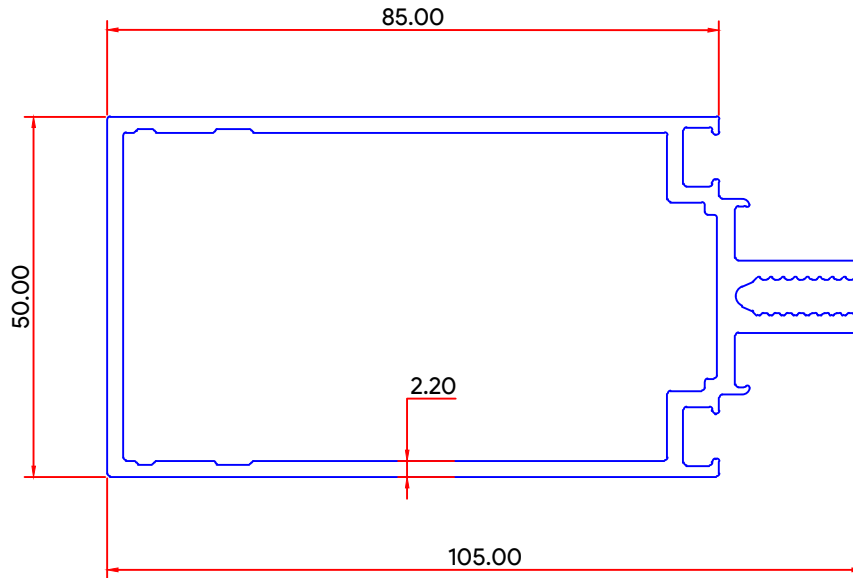

WEIGHT. : 6.932 KG / 12'

SEC. NO. : 6210

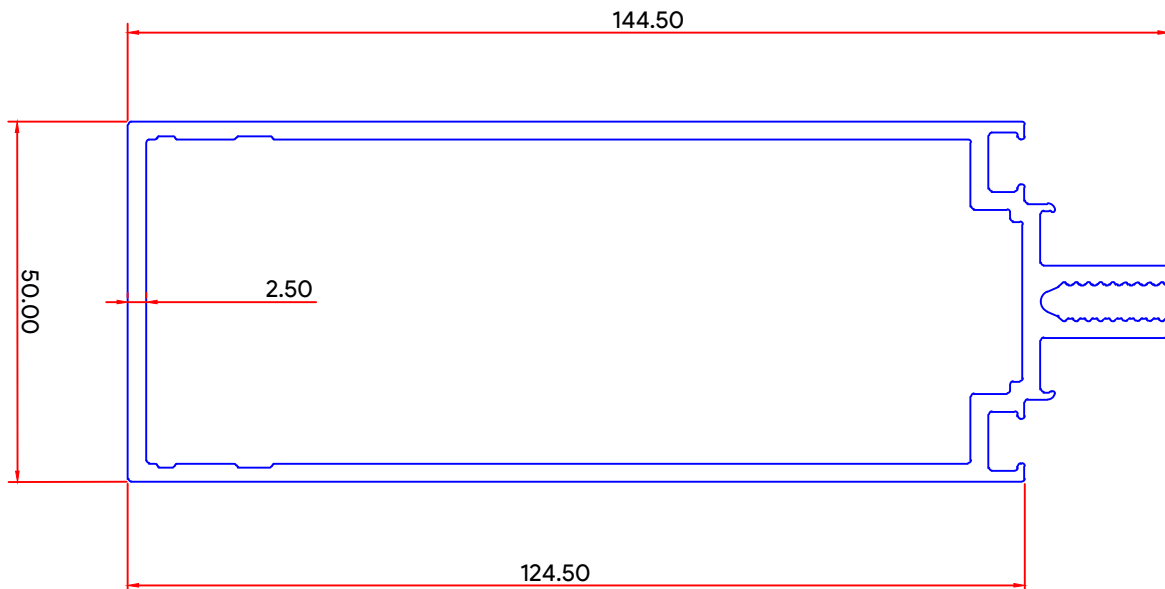

WEIGHT. : 9.564 KG / 12'



CURTAIN WALL SECTION

ARCHITECTURAL

SEC. NO. : 6230

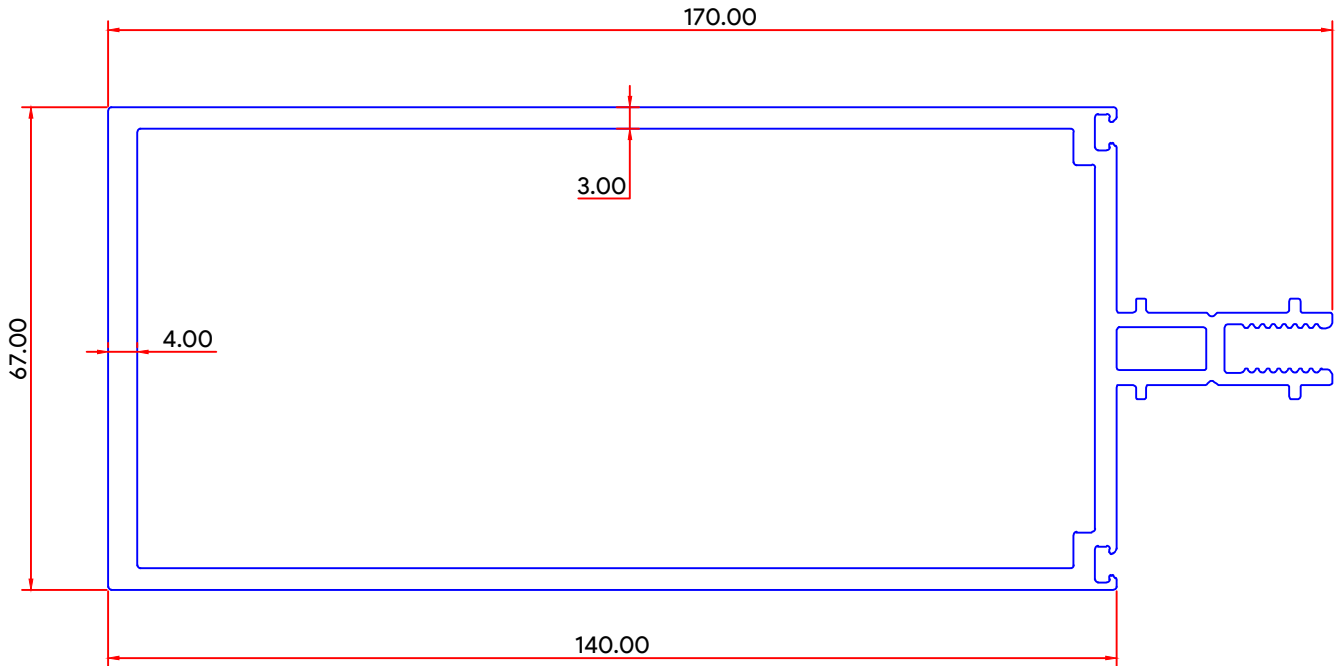

WEIGHT. : 14.095 KG / 12'

SEC. NO. : 6231

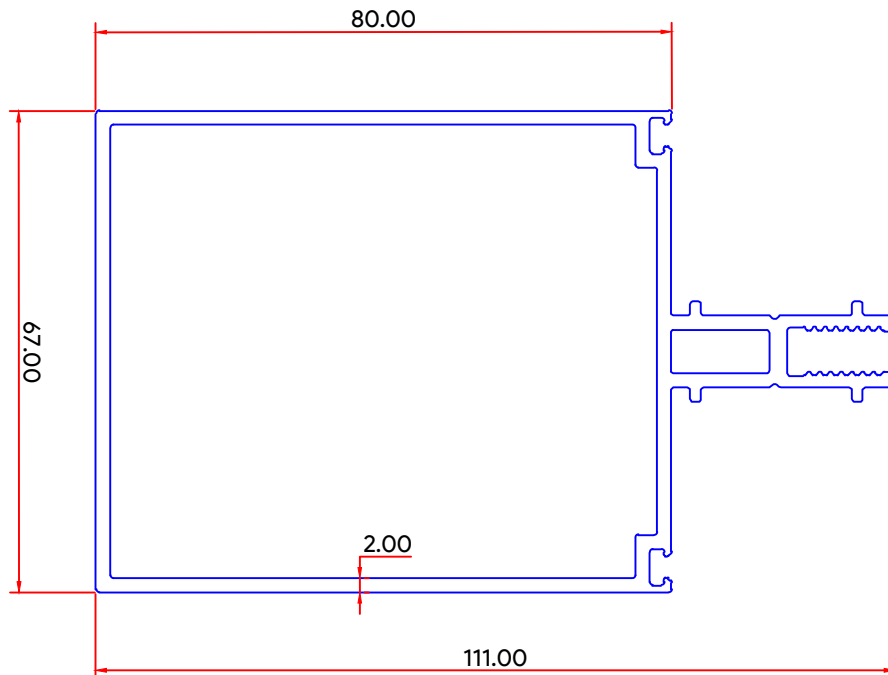

WEIGHT. : 7.146 KG / 12'



CURTAIN WALL SECTION

ARCHITECTURAL

SEC. NO. : 6243

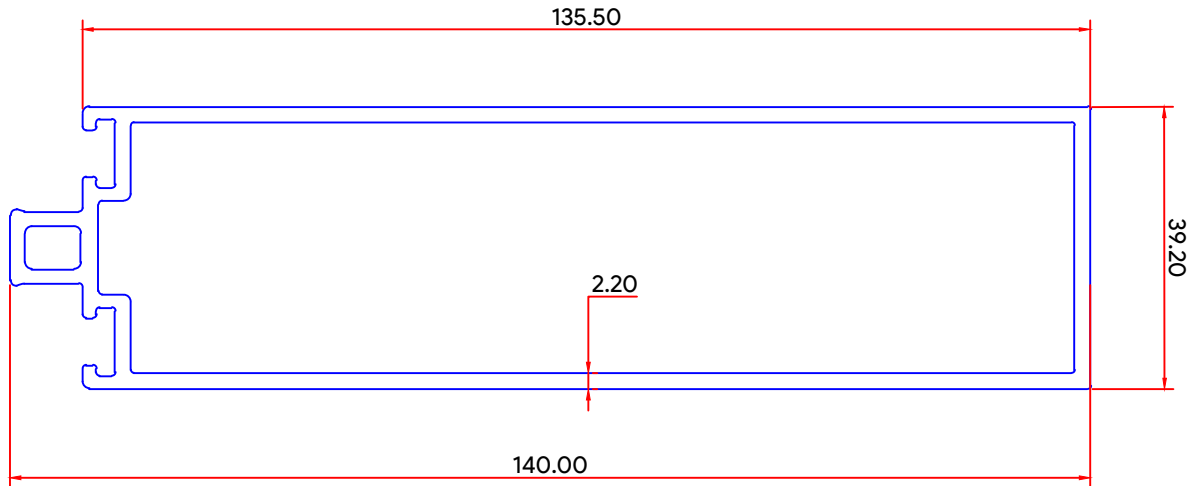

WEIGHT. : 8.825 KG / 12'

SEC. NO. : 8565

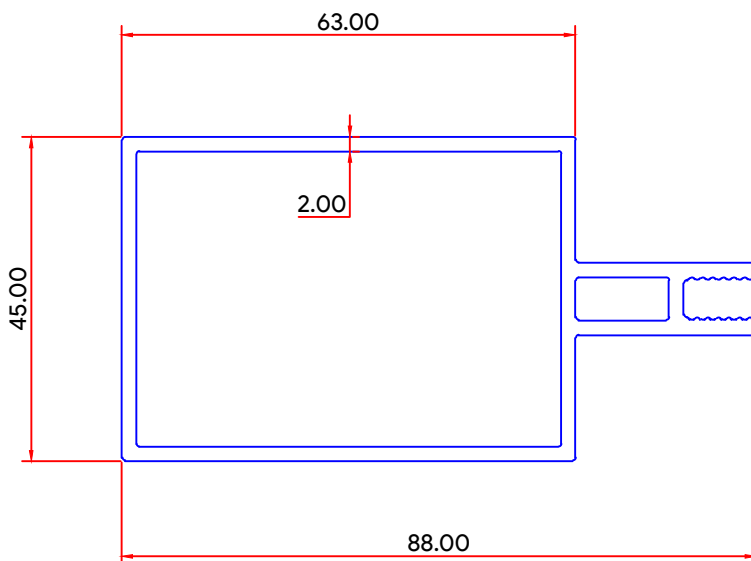

WEIGHT. : 5.255 KG / 12'

SEC. NO. : 7497

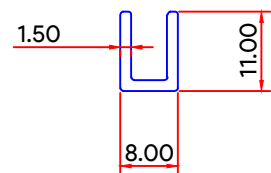

WEIGHT. : 0.905 KG / 12'

SEC. NO. : 7496

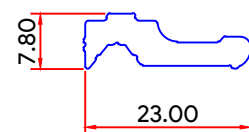

WEIGHT. : 0.989 KG / 12'



CURTAIN WALL SECTION

ARCHITECTURAL

SEC. NO. : 8566

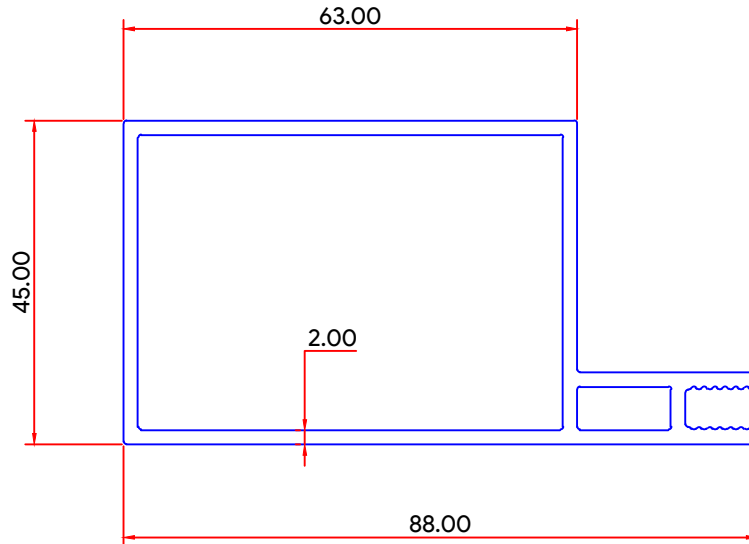

WEIGHT. : 5.255 KG / 12'

SEC. NO. : 6270

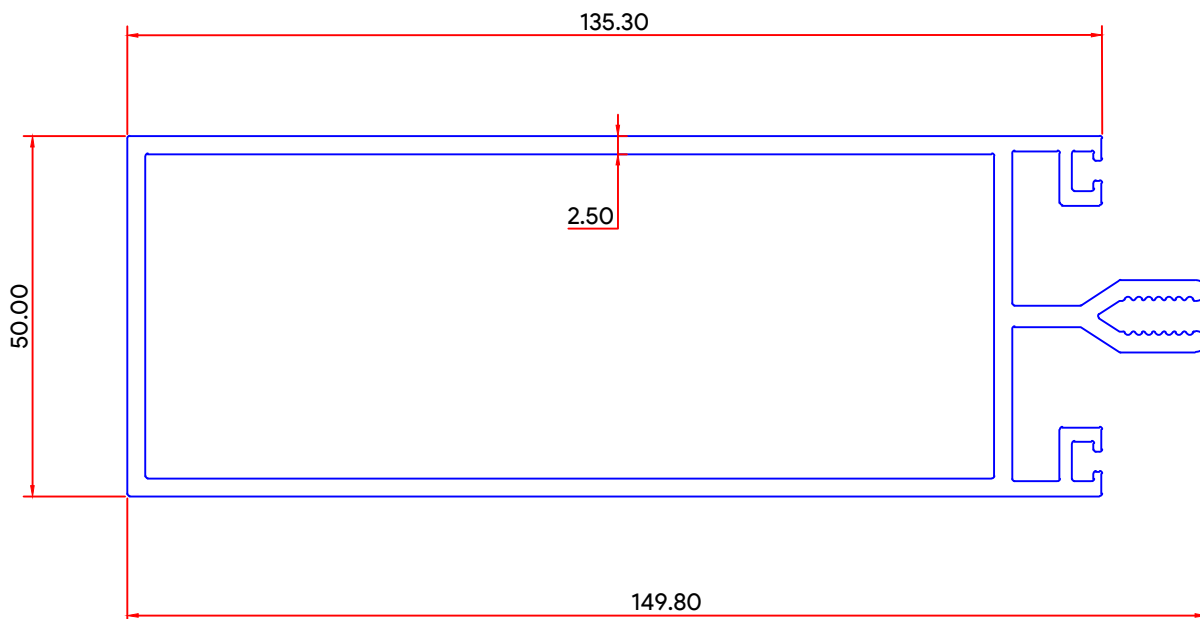

WEIGHT. : 10.434 KG / 12'



JHALANI EXTRUSION

(A UNIT OF P.R.C.M. METAL)

C-36, Riico Industrial Area, Neemrana, District : Alwar, (Raj.) 301705
Contact : 9716031516, 09953239231 E-Mail : jhalaniextrusion@yahoo.com

CURTAIN WALL SECTION

ARCHITECTURAL

SEC. NO. : 6272

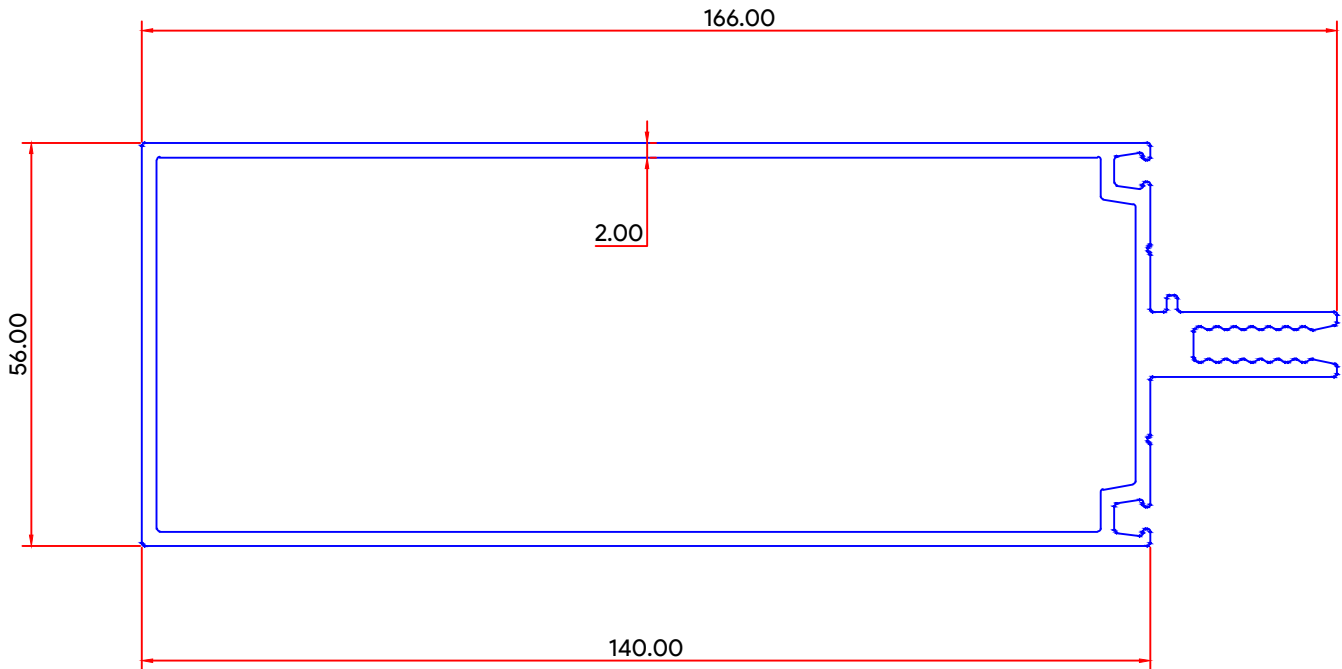

WEIGHT. : 9.213 KG / 12'

SEC. NO. : 6273

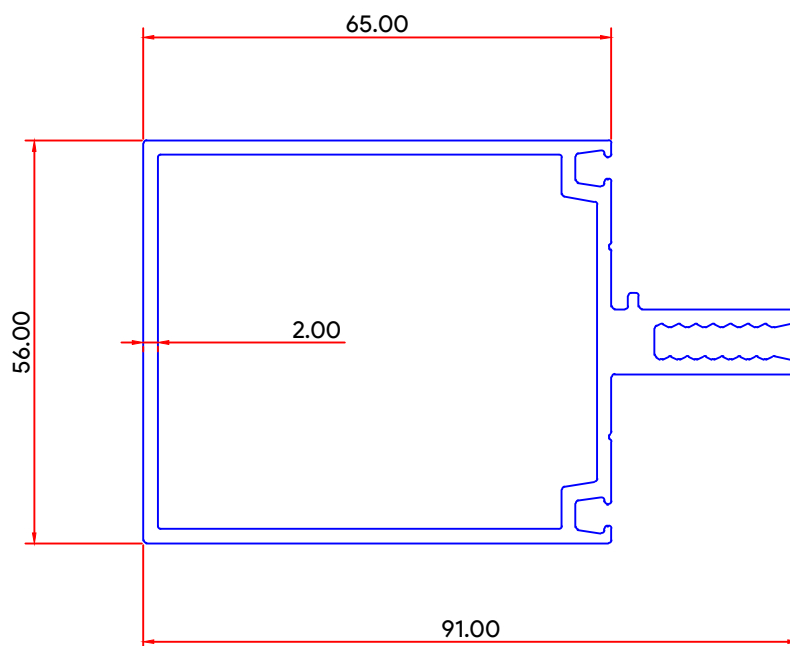

WEIGHT. : 6.248 KG / 12'

ALL DIMENSIONS ARE IN M.M.



JHALANI EXTRUSION

(A UNIT OF P.R.C.M. METAL)

C-36, Riico Industrial Area, Neemrana, District : Alwar, (Raj.) 301705

Contact : 9716031516, 09953239231 E-Mail : jhalaniextrusion@yahoo.com

CURTAIN WALL SECTION

ARCHITECTURAL

SEC. NO. : 6277

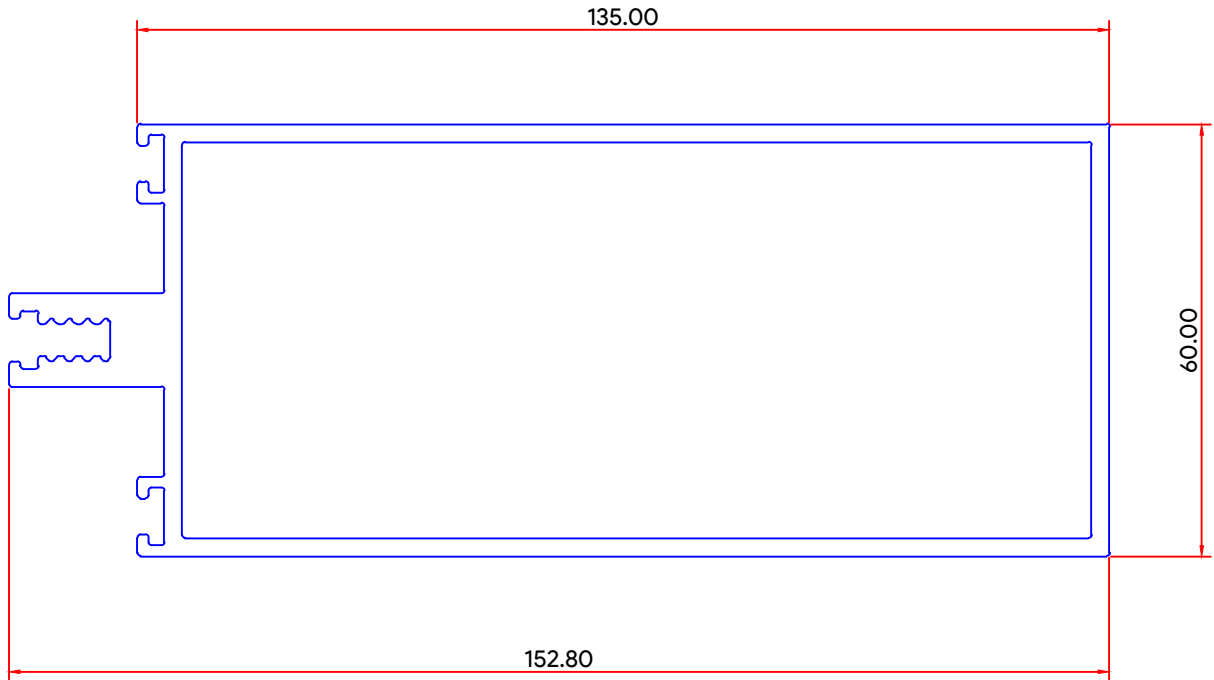

WEIGHT. : 11.480 KG / 12'

SEC. NO. : 8620

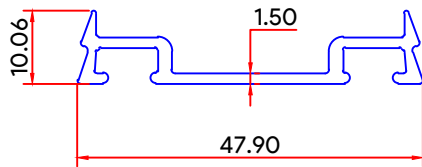

WEIGHT. : 1.183 KG / 12'

SEC. NO. : 8621

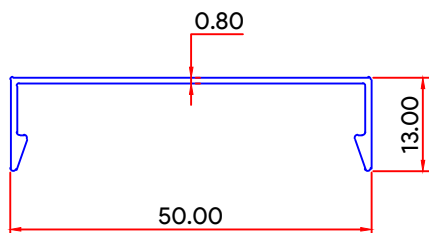

WEIGHT. : 0.658 KG / 12'

ALL DIMENSIONS ARE IN M.M.